

UCC12050 High-Efficiency, Low-EMI, 5-kV_{RMS} Reinforced Isolation DC-DC Converter

1 Features

- High-efficiency DC-DC converter with integrated transformer technology
- Meets CISPR32 Class B EMI limits without ferrite beads across entire load range on a 2-layer PCB
- Robust isolation barrier:
 - Isolation rating: 5 kV_{RMS}
 - Surge capability: 10 kV_{PK}
 - Working voltage: 1.2 kV_{RMS}
 - CMTI (typical): ±100 V/ns
- Output power (typical): 500-mW
- Regulated 5.0-V or 3.3-V output with selectable 400-mV headroom voltage to power an LDO
- Input voltage: 4.5 V to 5.5 V
- Short circuit recovery
- Thermal shutdown
- 16-pin wide-body SOIC package with > 8-mm creepage and clearance
- Extended temperature range: –40°C to 125°C
- Planned safety-related certifications:
 - 7071-V_{PK} reinforced isolation per DIN V VDE V 0884-11:2017-01
 - 5000-V_{RMS} isolation for 1 minute per UL 1577
 - CSA certification per IEC 60950-1, IEC 62368-1 and IEC 60601-1 end equipment standards
 - CQC approval per GB4943.1-2011

2 Applications

- PLC analog input and output modules
- Isolated voltage and current sensing
- Protection relays and smart breakers
- RS-485/RS-422/CAN transceiver
- Patient monitoring
- Isolated communications module

3 Description

UCC12050 is a DC/DC converter with 5-kV_{RMS} reinforced isolation rating designed to provide efficient, isolated power to isolated circuits that require a bias supply with a well-regulated output voltage. The device integrates a transformer and DC/DC controller with a proprietary architecture to provide 500 mW (typical) of isolated power with high efficiency and low EMI.

The UCC12050 integrates protection features for increased system robustness. The device also has an enable pin, synchronization capability, and regulated 5-V or 3.3-V output options with headroom. The UCC12050 is a low-profile, miniaturized solution offered in a wide-body SOIC package with 2.65-mm height (typical).

Device Information⁽¹⁾

PART NUMBER	PACKAGE	BODY SIZE (NOM)
UCC12050	DVE SOIC (16)	10.30 mm × 7.50 mm

(1) For all available packages, see the orderable addendum at the end of the data sheet.

Simplified Application

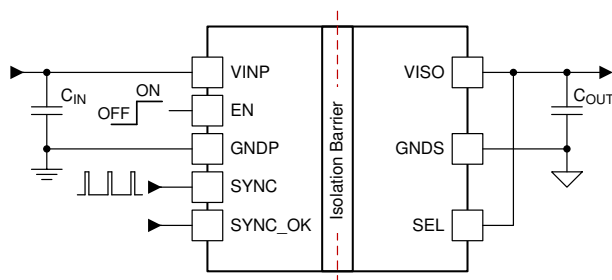

Typical Efficiency vs. Load

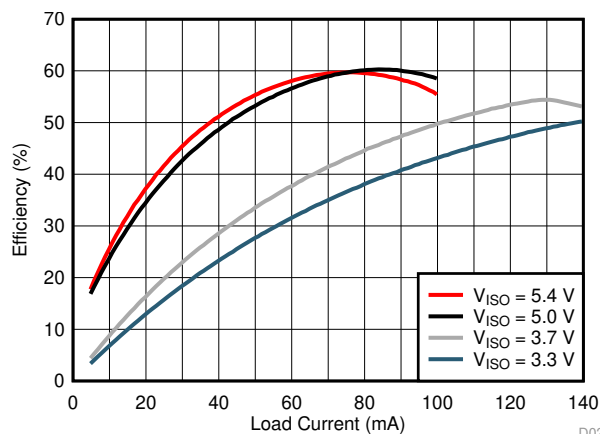

V_{INP} = 5.0 V

T_A = 25°C

D021



Table of Contents

1 Features	1	7.2 Functional Block Diagram	14
2 Applications	1	7.3 Feature Description	14
3 Description	1	7.4 Device Functional Modes	17
4 Revision History	2	8 Application and Implementation	18
5 Pin Configuration and Functions	3	8.1 Application Information	18
6 Specifications	4	8.2 Typical Application	18
6.1 Absolute Maximum Ratings	4	9 Power Supply Recommendations	24
6.2 ESD Ratings	4	10 Layout	24
6.3 Recommended Operating Conditions	4	10.1 Layout Guidelines	24
6.4 Thermal Information	4	10.2 Layout Example	25
6.5 Power Ratings	5	11 Device and Documentation Support	26
6.6 Insulation Specifications	5	11.1 Device Support	26
6.7 Safety-Related Certifications	6	11.2 Documentation Support	26
6.8 Safety Limiting Values	6	11.3 Receiving Notification of Documentation Updates	26
6.9 Electrical Characteristics	7	11.4 Community Resources	26
6.10 Switching Characteristics	8	11.5 Trademarks	26
6.11 Insulation Characteristics Curves	9	11.6 Electrostatic Discharge Caution	26
6.12 Typical Characteristics	10	11.7 Glossary	26
7 Detailed Description	14	12 Mechanical and Packaging Information	26
7.1 Overview	14		

4 Revision History

NOTE: Page numbers for previous revisions may differ from page numbers in the current version.

Changes from Revision B (December 2019) to Revision C	Page
• Added updates to the text throughout the document.	1
• Added footnote to Insulation Specifications table	5

Changes from Revision A (September 2019) to Revision B	Page
• Changed marketing status from Advance Information to Initial Release	1

5 Pin Configuration and Functions

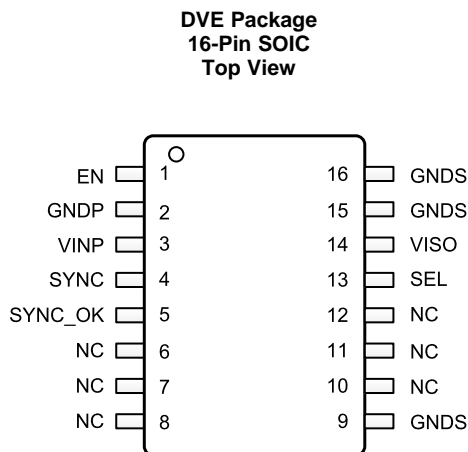
Table 1. Pin Functions

PIN		TYPE ⁽¹⁾	DESCRIPTION
NAME	NO.		
EN	1	I	Enable pin. Forcing EN low disables the device. Pull high to enable normal device functionality.
GNDP	2	P	Power ground return connection for VINP.
GNDS	9	P	Connect to GNDS plane on printed circuit board. Do not use as only ground connection for VISO. Ensure pin 15 is connected to circuit ground.
	16		
GNDS	15	P	Secondary side ground return connection for VISO. Connect bypass capacitor from VISO to this pin.
NC	6	—	Pins internally connected together. No other electrical connection. Pins belong to primary-side voltage domain. Connect to GNDP on printed circuit board.
	7		
	8		
	10	—	No internal connection. Pin belongs to isolated voltage domain. Connect to GNDS on printed circuit board.
	11		
12			
SYNC	4	I	Synchronous clock input pin. Provide a clock signal to synchronize multiple UCC12050 devices or connect to GNDP for standalone operation using the internal oscillator. If the SYNC pin is left open make sure to separate it from any switching noise to avoid false clock coupling.
SYNC_OK	5	O	Active-low, open-drain diagnostic output. Pin is asserted LOW if there is no external SYNC clock or one that is outside of the operating range of the UCC12050 is detected. In this state, the external clock is ignored and the DC-DC converter is clocked by the internal oscillator. The pin is in high-impedance if a clock is applied on SYNC.
SEL	13	I	V _{ISO} selection pin. V _{ISO} setpoint is 5.0 V when SEL is shorted to V _{ISO} , 5.4 V when SEL is connected to V _{ISO} through a 100-kΩ resistor, 3.3 V when SEL is shorted to GNDS, and 3.7 V when SEL is connected to GNDS through a 100-kΩ resistor. For more information see the Device Functional Modes section.
VINP	3	P	Primary side input supply voltage pin. A 10-μF ceramic capacitor to GNDP on pin 2, placed close to the device pins, is required.
VISO	14	P	Isolated supply voltage pin. A 10-μF ceramic capacitor to GNDS on pin 15, placed close to the device pins, is required. See VISO Output Capacitor Selection section.

(1) P = Power, G = Ground, I = Input, O = Output

6 Specifications

6.1 Absolute Maximum Ratings

over operating free-air temperature range (unless otherwise noted)⁽¹⁾

	MIN	MAX	UNIT
V _{INP} to GNNDP	-0.3	6.0	V
EN, SYNC, SYNC_OK, to GNNDP	-0.3	V _{INP} + 0.3, ≤ 6.0	V
V _{ISO} to GNDS	-0.3	6.0	V
SEL to GNDS	-0.3	V _{ISO} + 0.3, ≤ 6.0	V
V _{ISO} output power at T _a = 25°C, P _{OUT_MAX} ⁽²⁾		675	mW
Operating junction temperature range, T _J	-40	150	°C
Storage temperature, T _{stg}	-65	150	°C

- (1) Stresses beyond those listed under *Absolute Maximum Ratings* may cause permanent damage to the device. These are stress ratings only, which do not imply functional operation of the device at these or any other conditions beyond those indicated under *Recommended Operating Conditions*. Exposure to absolute-maximum-rated conditions for extended periods may affect device reliability.
- (2) See the [V_{ISO} Load Recommended Operating Area](#) section for maximum rated values across temperature and V_{INP} conditions for each different V_{ISO} output mode.

6.2 ESD Ratings

			VALUE	UNIT
V _(ESD)	Electrostatic discharge	Human-body model (HBM), per ANSI/ESDA/JEDEC JS-001 ⁽¹⁾	±1000	V
		Charged-device model (CDM), per JEDEC specification JESD22-C101 ⁽²⁾	±500	

- (1) JEDEC document JEP155 states that 500-V HBM allows safe manufacturing with a standard ESD control process.
- (2) JEDEC document JEP157 states that 250-V CDM allows safe manufacturing with a standard ESD control process.

6.3 Recommended Operating Conditions

over operating free-air temperature range (unless otherwise noted)

		MIN	NOM	MAX	UNIT
V _{INP}	Primary side supply voltage	4.5	5.0	5.5	V
V _{EN}	EN pin input voltage	0		5.5	V
V _{SYNC}	SYNC pin input voltage	0		5.5	V
V _{SYNC-OK}	SYNC_OK pin drain pin voltage	0		5.5	V
V _{ISO}	Isolated power supply voltage	0		5.7	V
V _{SEL}	Input voltage	0		5.7	V
f _{SYNC}	External DC-DC converter synchronization signal frequency	14.4	16.0	17.6	MHz
P _{VISO}	V _{ISO} output power at T _a = 25°C ⁽¹⁾			500	mW
T _a	Ambient temperature	-40		125	°C
T _J	Junction temperature	-40		150	°C

- (1) See the [V_{ISO} Load Recommended Operating Area](#) section for maximum rated values across temperature and V_{INP} conditions for each different V_{ISO} output mode.

6.4 Thermal Information

THERMAL METRIC ⁽¹⁾		UCC12050	UNIT
		DVE (SOIC)	
		16 PINS	
R _{θJA}	Junction-to-ambient thermal resistance	63.8	°C/W
R _{θJC(top)}	Junction-to-case (top) thermal resistance	21.4	°C/W
R _{θJB}	Junction-to-board thermal resistance	38.5	°C/W
ψ _{JT}	Junction-to-top characterization parameter	10.2	°C/W
ψ _{JB}	Junction-to-board characterization parameter	37.2	°C/W
R _{θJC(bot)}	Junction-to-case (bottom) thermal resistance	—	°C/W

- (1) For more information about traditional and new thermal metrics, see the [Semiconductor and IC Package Thermal Metrics](#) application report.

6.5 Power Ratings

 $V_{INP} = 5.0V$, $C_{INP} = C_{OUT} = 10 \mu F$, $T_J = 150^\circ C$, Internal Clock mode

PARAMETER		TEST CONDITIONS	VALUE	UNIT
P_D	Power dissipation	SEL connected to GNDS (3.3-V V_{ISO} output mode), $I_{ISO} = 135 \text{ mA}$	460	mW
P_{DP}	Power dissipation by driver side (primary)		148	mW
P_{DS}	Power dissipation by rectifier side (secondary)		164	mW
P_{DT}	Power dissipation by transformer		148	mW

6.6 Insulation Specifications

PARAMETER		TEST CONDITIONS	VALUE	UNIT
GENERAL				
CLR	External clearance ⁽¹⁾	Shortest terminal-to-terminal distance through air	> 8	mm
CPG	External creepage ⁽¹⁾	Shortest terminal-to-terminal distance across the package surface	> 8	mm
DTI	Distance through the insulation	Minimum internal gap (internal clearance)	> 120	μm
CTI	Comparative tracking index	DIN EN 60112 (VDE 0303-11); IEC 60112	> 600	V
	Material group	According to IEC 60664-1	I	
	Overvoltage Category	Rated mains voltage $\leq 300 V_{RMS}$	I-IV	
		Rated mains voltage $\leq 600 V_{RMS}$	I-IV	
		Rated mains voltage $\leq 1000 V_{RMS}$	I-III	
DIN V VDE V 0884-11:2017-01⁽²⁾ (Planned Certification Targets)				
V_{IORM}	Maximum repetitive peak isolation voltage	AC voltage (bipolar)	1414	V_{PK}
V_{IOWM}	Maximum working isolation voltage	AC voltage (sine wave) Time dependent dielectric breakdown (TDDB) test	1000	V_{RMS}
		DC voltage	1414	V_{DC}
V_{IOTM}	Maximum transient isolation voltage	$V_{TEST} = V_{IOTM}$, $t = 60s$ (qualification); $V_{TEST} = 1.2 \times V_{IOTM}$, $t = 1s$ (100% production)	7071	V_{PK}
V_{IOSM}	Maximum surge isolation voltage ⁽³⁾	Test method per IEC 62368-1, 1.2/50 μs waveform, $V_{TEST} = 1.6 \times V_{IOSM} = 10000 V_{PK}$ (qualification)	6250	V_{PK}
q_{pd}	Apparent charge ⁽⁴⁾	Method a: After I/O safety test subgroup 2/3, $V_{ini} = V_{IOTM}$, $t_{ini} = 60 s$; $V_{pd(m)} = 1.2 \times V_{IORM} = 1696 V_{PK}$, $t_m = 10 s$	≤ 5	pC
		Method a: After environmental tests subgroup 1, $V_{ini} = V_{IOTM}$, $t_{ini} = 60 s$; $V_{pd(m)} = 1.6 \times V_{IORM} = 2262 V_{PK}$, $t_m = 10 s$	≤ 5	
		Method b1: At routine test (100% production) and preconditioning (type test) $V_{ini} = 1.2 \times V_{IOTM}$, $t_{ini} = 1 s$; $V_{pd(m)} = 1.875 \times V_{IORM} = 2651 V_{PK}$, $t_m = 1 s$	≤ 5	
C_{IO}	Barrier capacitance, input to output ⁽⁵⁾	$V_{IO} = 0.4 \sin(2\pi ft)$, $f = 1 \text{ MHz}$	~3.5	pF
R_{IO}	Isolation resistance, input to output ⁽⁵⁾	$V_{IO} = 500 V$, $T_A = 25^\circ C$	$> 10^{12}$	Ω
		$V_{IO} = 500 V$, $100^\circ C \leq T_A \leq 125^\circ C$	$> 10^{11}$	
		$V_{IO} = 500 V$ at $T_S = 150^\circ C$	$> 10^9$	
	Pollution degree		2	
	Climatic category		40/125/21	
UL 1577 (Planned Certification Target)				
V_{ISO}	Withstand isolation voltage	$V_{TEST} = V_{ISO} = 5000 V_{RMS}$, $t = 60 s$ (qualification); $V_{TEST} = 1.2 \times V_{ISO} = 6000 V_{RMS}$, $t = 1 s$ (100% production)	5000	V_{RMS}

- Creepage and clearance requirements should be applied according to the specific equipment isolation standards of an application. Care should be taken to maintain the creepage and clearance distance of a board design to ensure that the mounting pads of the isolator on the printed-circuit board do not reduce this distance. Creepage and clearance on a printed-circuit board become equal in certain cases. Techniques such as inserting grooves and/or ribs on a printed circuit board are used to help increase these specifications.
- This coupler is suitable for *safe electrical insulation* only within the maximum operating ratings. Compliance with the safety ratings shall be ensured by means of suitable protective circuits.
- Testing is carried out in air or oil to determine the intrinsic surge immunity of the isolation barrier.
- Apparent charge is electrical discharge caused by a partial discharge (pd).
- All pins on each side of the barrier tied together creating a two-terminal device

6.7 Safety-Related Certifications

VDE	CSA	UL	CQC	TUV
Plan to certify according to DIN V VDE V 0884-11:2017-01	Plan to certify according to IEC 60950-1, IEC 62368-1, and IEC 60601-1	Plan to certify under UL 1577 Component Recognition Program	Plan to certify according to GB4943.1-2011	Plan to certify according to EN 61010-1:2010 (3rd Ed) and EN 60950-1:2006/A11:2009/A1:2010/A12:2011/A2:2013
Reinforced insulation Maximum transient isolation voltage, 7071 V _{PK} ; Maximum repetitive peak isolation voltage, 1414 V _{PK} ; Maximum surge isolation voltage, 6250 VPK	Reinforced insulation per CSA 60950-1-07+A1+A2, IEC 60950-1 2nd Ed.+A1+A2, CSA 62368-1-14 and IEC 62368-1 2nd Ed., 800 V _{RMS} maximum working voltage (pollution degree 2, material group I) ; 2 MOPP (Means of Patient Protection) per CSA 60601-1:14 and IEC 60601-1 Ed.3+A1, 250 V _{RMS} maximum working voltage	Single protection, 5000 V _{RMS}	Reinforced insulation, Altitude ≤ 5000 m, Tropical Climate, 700 V _{RMS} maximum working voltage	5000 V _{RMS} Reinforced insulation per EN 61010-1:2010 (3rd Ed) up to working voltage of 600 V _{RMS} 5000 V _{RMS} Reinforced insulation per EN 60950-1:2006/A11:2009/A1:2010/A12:2011/A2:2013 up to working voltage of 800 V _{RMS}
Certificate number: (planned)	Master contract number: (planned)	File number: (planned)	Certificate number: (planned)	Client ID number: (planned)

6.8 Safety Limiting Values

Safety limiting intends to minimize potential damage to the isolation barrier upon failure of input or output circuitry.

PARAMETER		TEST CONDITIONS	MAX	UNIT
I _S	Safety input current ⁽¹⁾	R _{θJA} = 63.8°C/W, V _I = 5.5 V, T _J = 150°C, T _A = 25°C	356	mA
		R _{θJA} = 63.8°C/W, V _I = 4.5 V, T _J = 150°C, T _A = 25°C	435	
P _S	Safety input power	R _{θJA} = 63.8°C/W, T _J = 150°C, T _A = 25°C	1960	mW
T _S	Safety temperature ⁽¹⁾		150	°C

(1) The maximum safety temperature, T_S, has the same value as the maximum junction temperature, T_J, specified for the device. The I_S and P_S parameters represent the safety current and safety power respectively. The maximum limits of I_S and P_S should not be exceeded. These limits vary with the ambient temperature, T_A. The junction-to-air thermal resistance, R_{θJA}, in the [Thermal Information](#) table is that of a device installed on a high-K test board for leaded surface-mount packages. Use these equations to calculate the value for each parameter: T_J = T_A + R_{θJA} × P, where P is the power dissipated in the device. T_{J(max)} = T_S = T_A + R_{θJA} × P_S, where T_{J(max)} is the maximum allowed junction temperature. P_S = I_S × V_I, where V_I is the maximum input voltage.

6.9 Electrical Characteristics

Over operating temperature range ($T_J = -40^{\circ}\text{C}$ to 150°C), $V_{\text{INP}} = 4.5\text{V}$ to 5.5V , $C_{\text{INP}} = C_{\text{OUT}} = 10\ \mu\text{F}$, SEL connected to V_{ISO} , unless otherwise noted. All typical values at $T_J = 25^{\circ}\text{C}$ and $V_{\text{INP}} = 5.0\text{V}$.

	PARAMETER	TEST CONDITIONS	MIN	TYP	MAX	UNIT
INPUT SUPPLY						
I_{VINQ}	VINP quiescent current, disabled	EN=LOW			100	μA
I_{VINO}	VINP operating current, no load	EN=HI; SEL shorted to VISO (5.0V output)		50		mA
		EN=HI; SEL 100k Ω to VISO (5.4V output)		45		
		EN=HI; SEL shorted to GNDS (3.3V output)		90		
		EN=HI; SEL 100k Ω to GNDS (3.7V output)		80		
$I_{\text{VIN_SC}}$	DC current from VINP supply under short circuit on VISO	VISO short to GNDS		245		mA
V_{UVPR}	VINP under-voltage lockout rising threshold			4.2		V
V_{UVPF}	VINP under-voltage lockout falling threshold			3.7		V
V_{UVPH}	VINP under-voltage lockout hysteresis			0.5		V
EN, SYNC INPUT PINS						
V_{IR}	Input voltage threshold, logic HIGH	Rising edge			2.2	V
V_{IF}	Input voltage threshold, logic LOW	Falling edge	0.8			V
I_{EN}	Enable Pin Input Current	$V_{\text{EN}} = 5.0\text{V}$		5	10	μA
I_{SYNC}	SYNC Pin Input Current	$V_{\text{SYNC}} = 5.0\text{V}$		0.02	1	μA
SYNC_OK PIN						
V_{OL}	SYNC_OK output low voltage	$I_{\text{SYNC_OK}} = -2\text{mA}$		0.15		V
$I_{\text{LKG_SYNC_OK}}$	SYNC_OK pin leakage current	$V_{\text{SYNC_OK}} = 5.0\text{V}$			1	μA
DC-DC CONVERTER						
V_{ISO}	Isolated supply output voltage	SEL shorted to VISO (5.0V output); $I_{\text{ISO}} = 55\text{mA}$ ⁽¹⁾	4.7	5	5.3	V
		SEL 100k Ω to VISO (5.4V output); $I_{\text{ISO}} = 45\text{mA}$ ⁽¹⁾	5.1	5.4	5.7	V
		SEL shorted to GNDS (3.3V output); $I_{\text{ISO}} = 100\text{mA}$ ⁽¹⁾	3.1	3.3	3.5	V
		SEL 100k Ω to GNDS (3.7V output); $I_{\text{ISO}} = 90\text{mA}$ ⁽¹⁾	3.5	3.7	3.9	V
$V_{\text{ISO(RIP)}}$	Voltage ripple on isolated supply output (pk-pk)	20-MHz bandwidth, CLOAD = 10 μF 0.1 μF , SEL shorted to VISO (5.0V output); $I_{\text{ISO}} = 100\text{mA}$		50		mV
		20-MHz bandwidth, CLOAD = 10 μF 0.1 μF , SEL 100k Ω to VISO (5.4V output); $I_{\text{ISO}} = 90\text{mA}$		50		mV
		20-MHz bandwidth, CLOAD = 10 μF 0.1 μF , SEL shorted to GNDS (3.3V output); $I_{\text{ISO}} = 145\text{mA}$		50		mV
		20-MHz bandwidth, CLOAD = 10 μF 0.1 μF , SEL shorted to GNDS (3.7V output); $I_{\text{ISO}} = 130\text{mA}$		50		mV
$V_{\text{ISO(LINE)}}$	V_{ISO} DC line regulation	SEL shorted to VISO (5.0V output); $I_{\text{ISO}} = 50\text{mA}$, $V_{\text{INP}} = 4.5\text{V}$ to 5.5V		1%		
		SEL shorted to GNDS (3.3V output); $I_{\text{ISO}} = 75\text{mA}$, $V_{\text{INP}} = 4.5\text{V}$ to 5.5V		1%		

(1) See the [V_{ISO} Load Recommended Operating Area](#) section for discussion of V_{ISO} regulation across load and temperature conditions for all output voltage settings.

Electrical Characteristics (continued)

Over operating temperature range ($T_J = -40^{\circ}\text{C}$ to 150°C), $V_{INP} = 4.5\text{V}$ to 5.5V , $C_{INP} = C_{OUT} = 10\ \mu\text{F}$, SEL connected to V_{ISO} , unless otherwise noted. All typical values at $T_J = 25^{\circ}\text{C}$ and $V_{INP} = 5.0\text{V}$.

	PARAMETER	TEST CONDITIONS	MIN	TYP	MAX	UNIT
$V_{ISO(\text{LOAD})}$	V_{ISO} DC load regulation	SEL shorted to V_{ISO} (5.0 V output); $I_{ISO} = 0$ to 100 mA		1.5%		
	V_{ISO} DC load regulation	SEL shorted to GNDS (3.3 V output); $I_{ISO} = 0$ to 145 mA		1.5%		
EFF	Efficiency at maximum recommended load ⁽²⁾	SEL shorted to V_{ISO} (5.0 V output); $I_{ISO} = 100$ mA		60%		
		SEL 100k Ω to V_{ISO} (5.4V output); $I_{ISO} = 90$ mA		60%		
		SEL shorted to GNDS (3.3V output); $I_{ISO} = 145$ mA		50%		
		SEL 100k Ω to GNDS (3.7V output); $I_{ISO} = 130$ mA		53%		
t_{RISE}	V_{ISO} rise time, 10% - 90%	EN = change from LO to HI, SEL shorted to V_{ISO} (5.0V output); $I_{ISO} = 1$ mA		750		μs
		EN = change from LO to HI, SEL 100k Ω to GNDS (3.3V output); $I_{ISO} = 1$ mA		300		μs
THERMAL SHUTDOWN						
TSD_{THR}	Thermal shutdown threshold	Junction Temperature, Rising		165		$^{\circ}\text{C}$
TSD_{HYST}	Thermal shutdown hysteresis	Junction Temperature, Falling		27		$^{\circ}\text{C}$

(2) Efficiency calculation: $EFF = (V_{ISO} \times I_{ISO}) / (V_{INP} \times I_{INP})$

6.10 Switching Characteristics

Over operating temperature range ($T_J = -40^{\circ}\text{C}$ to 150°C), $V_{INP} = 4.5\text{V}$ to 5.5V , $C_{INP} = C_{OUT} = 10\ \mu\text{F}$, SEL connected to V_{ISO} , unless otherwise noted. All typical values at $T_J = 25^{\circ}\text{C}$ and $V_{INP} = 5.0\text{V}$.

	PARAMETER	TEST CONDITIONS	MIN	TYP	MAX	UNIT
f_{SYNC}	DC-DC Converter Clock	Internal clock mode	7.2	8	8.8	MHz
CMTI	Static common-mode transient immunity	Slew Rate of GNDP versus GNDS, $V_{CM} = 1000$ V		100		V/ns

6.11 Insulation Characteristics Curves

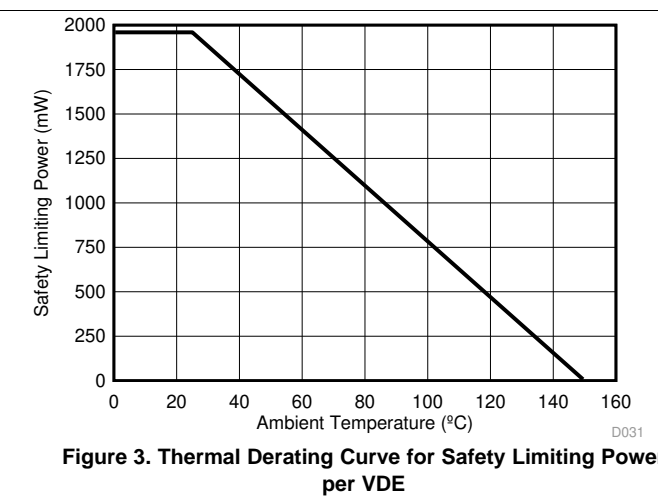
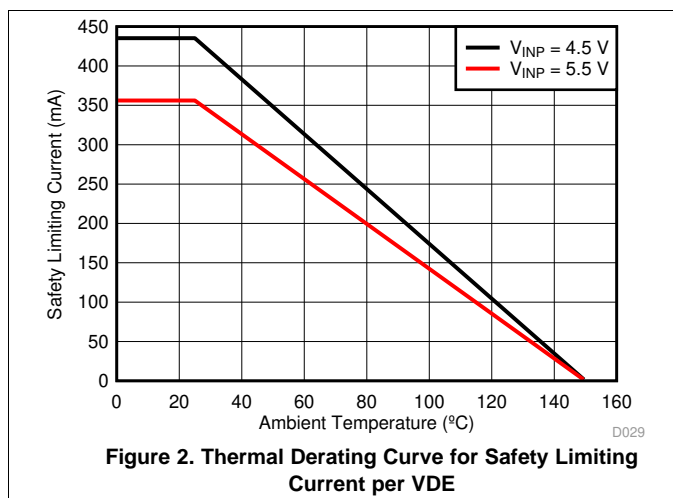
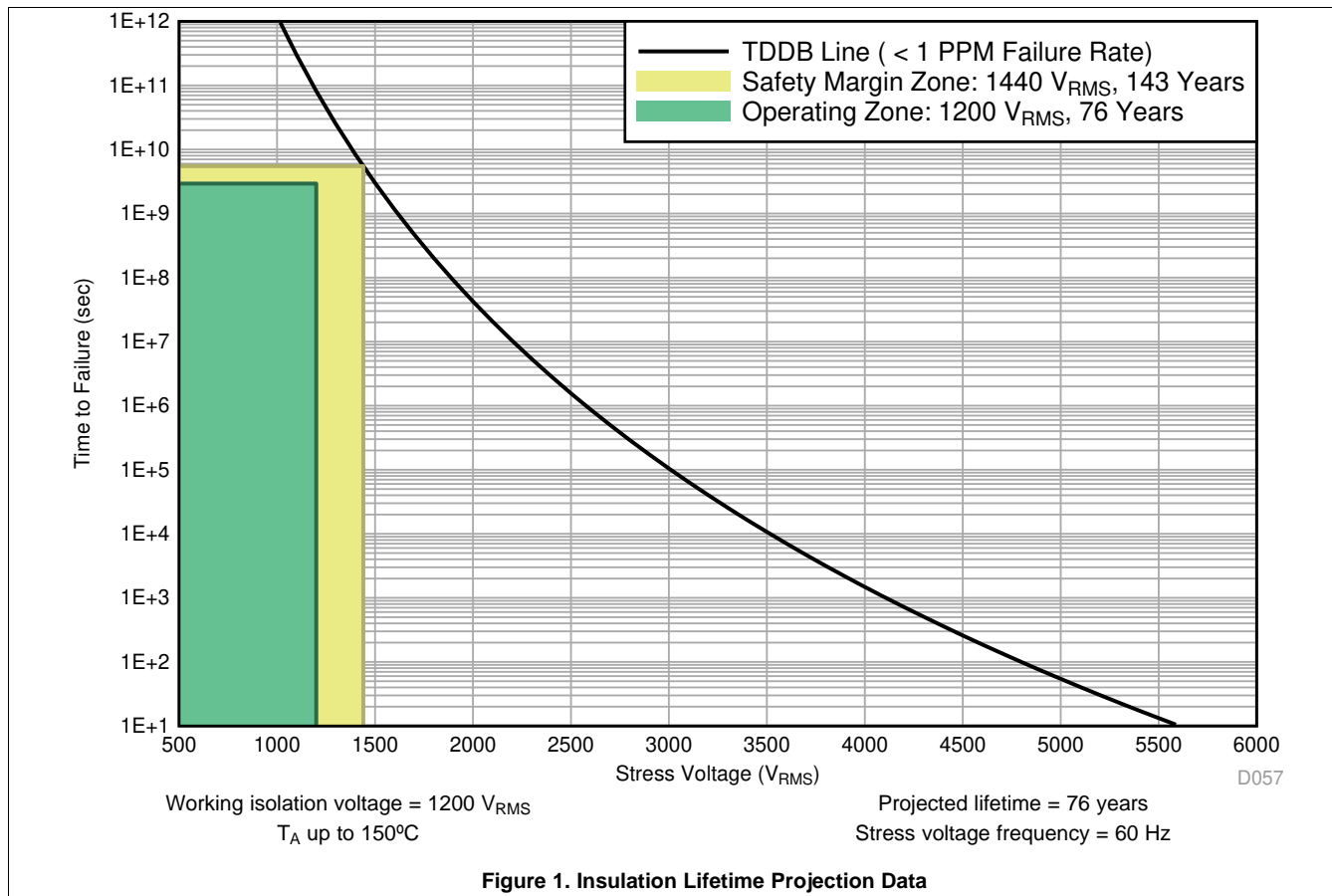

6.12 Typical Characteristics

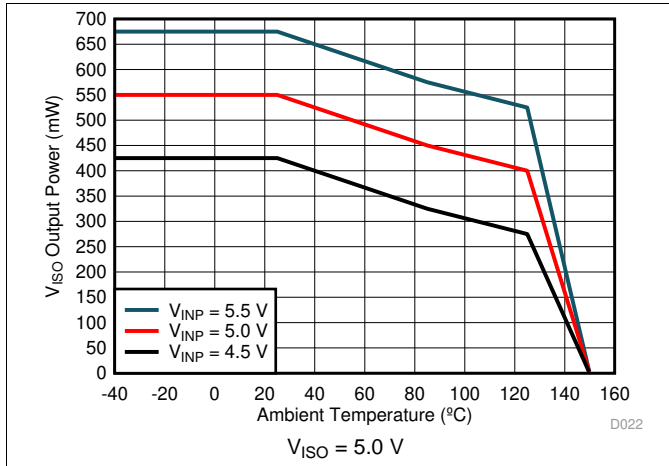

Figure 4. Maximum V_{ISO} Output Power vs. Temperature

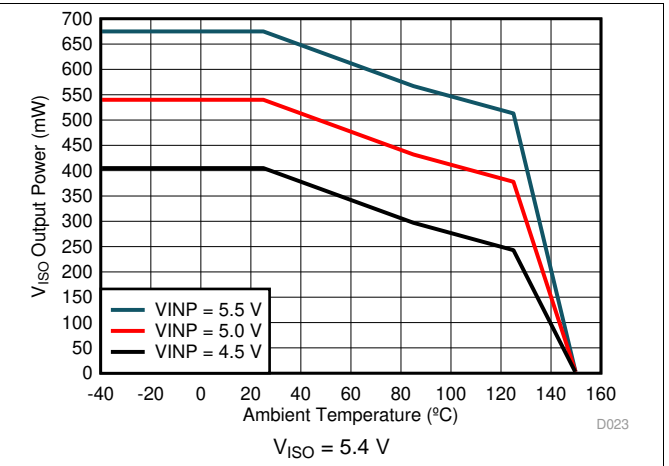

Figure 5. Maximum V_{ISO} Output Power vs. Temperature

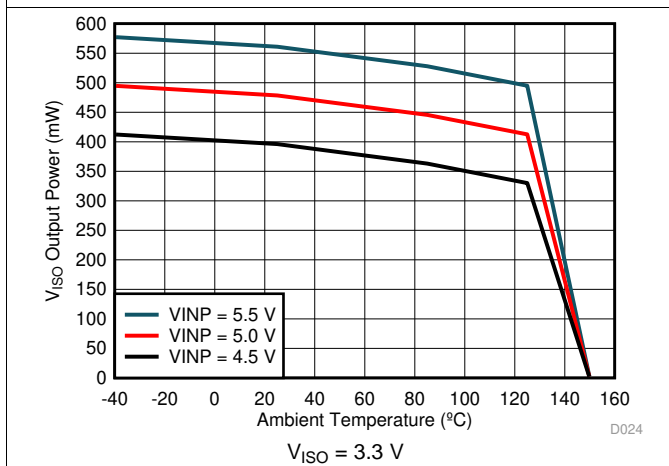

Figure 6. Maximum V_{ISO} Output Power vs. Temperature

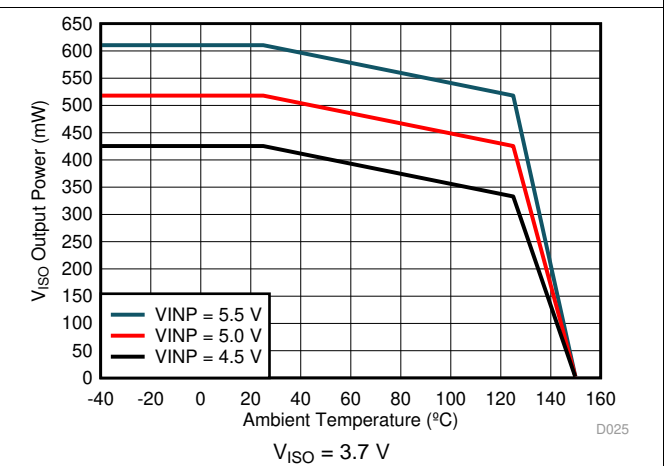

Figure 7. Maximum V_{ISO} Output Power vs. Temperature

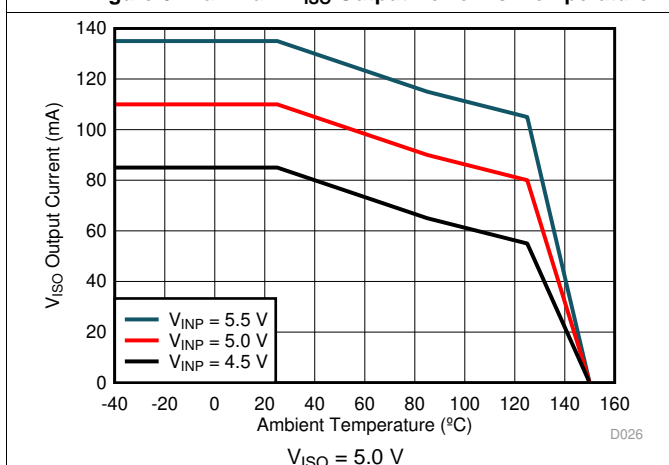

Figure 8. Maximum V_{ISO} Output Current vs. Temperature

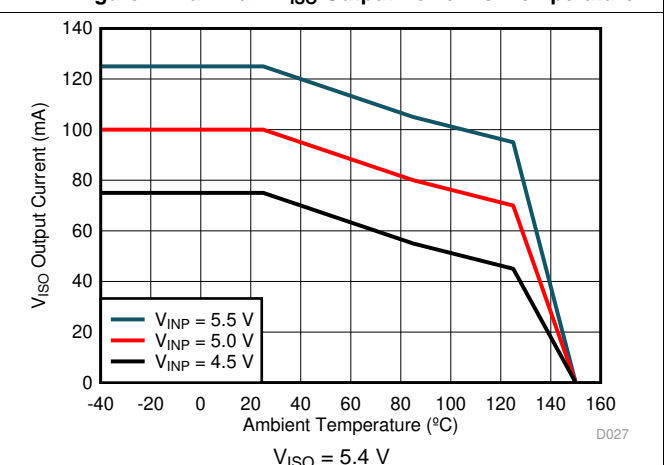

Figure 9. Maximum V_{ISO} Output Current vs. Temperature

Typical Characteristics (continued)

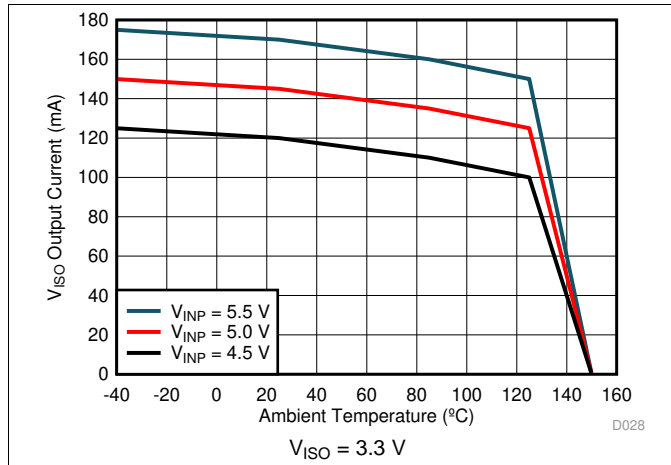

Figure 10. Maximum V_{ISO} Output Current vs. Temperature

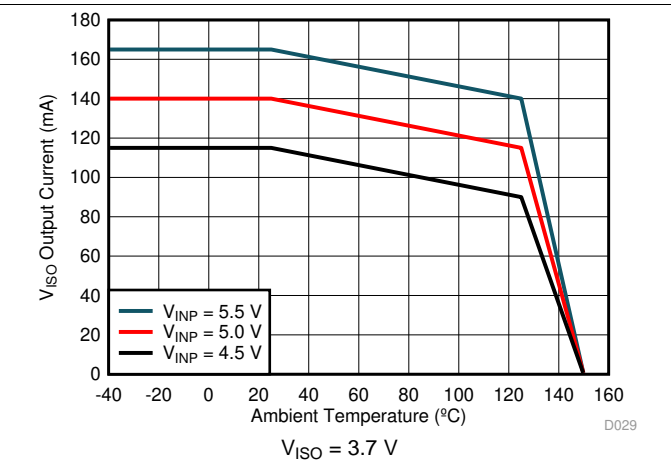

Figure 11. Maximum V_{ISO} Output Current vs. Temperature

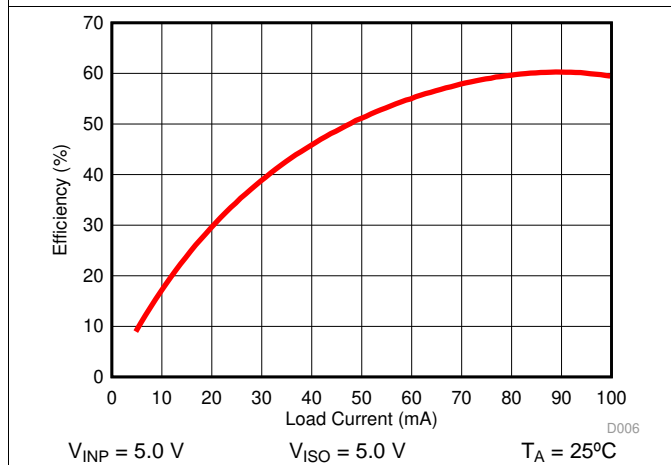

Figure 12. Power Supply Efficiency vs Load Current (I_{ISO})

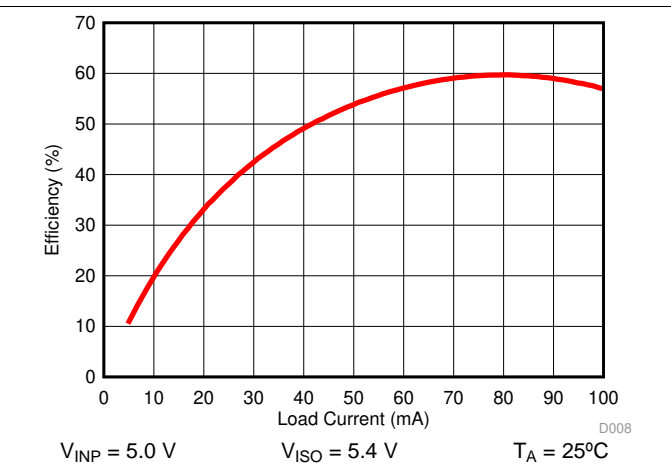

Figure 13. Power Supply Efficiency vs Load Current (I_{ISO})

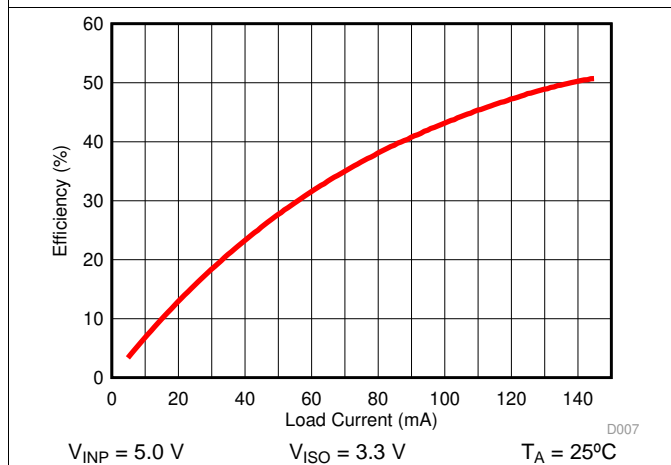

Figure 14. Power Supply Efficiency vs Load Current (I_{ISO})

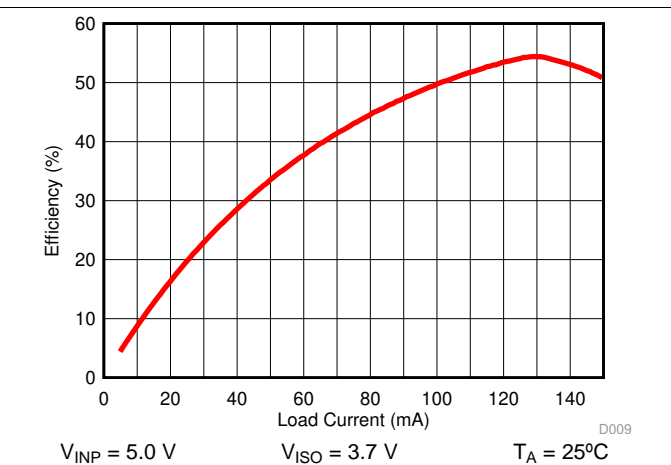

Figure 15. Power Supply Efficiency vs Load Current (I_{ISO})

Typical Characteristics (continued)

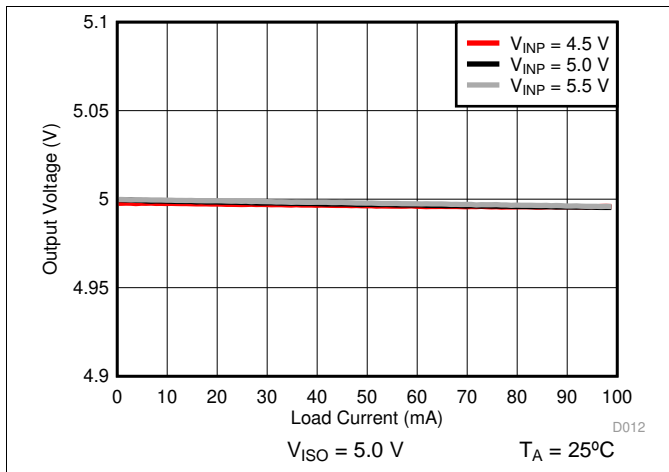

Figure 16. Isolated Supply Voltage (V_{ISO}) vs Load Current (I_{iso})

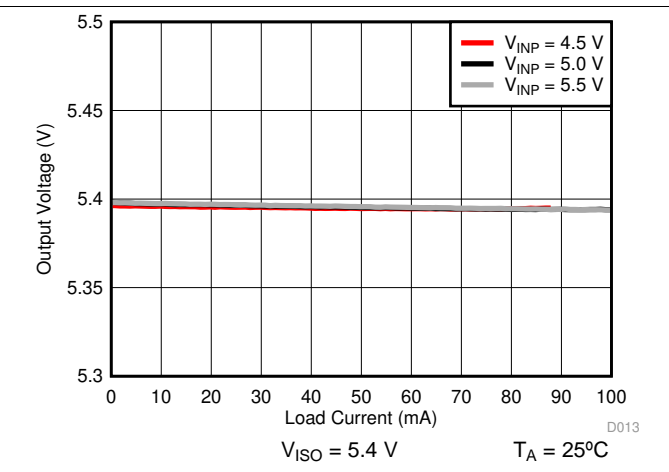

Figure 17. Isolated Supply Voltage (V_{ISO}) vs Load Current (I_{iso})

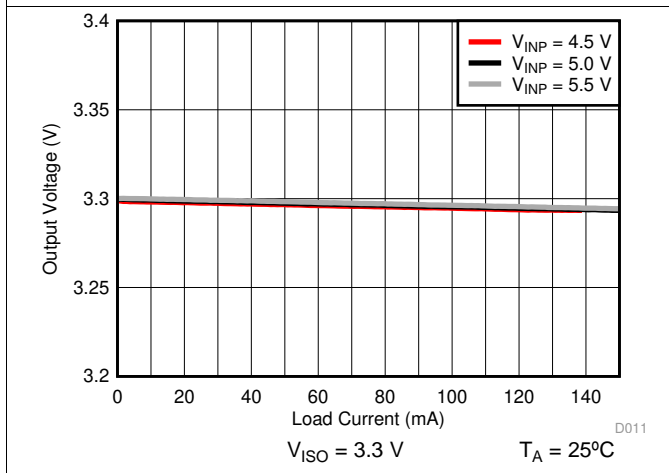

Figure 18. Isolated Supply Voltage (V_{ISO}) vs Load Current (I_{iso})

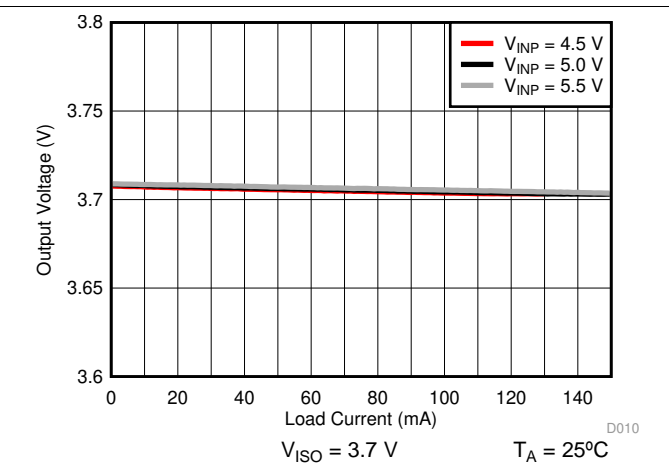

Figure 19. Isolated Supply Voltage (V_{ISO}) vs Load Current (I_{iso})

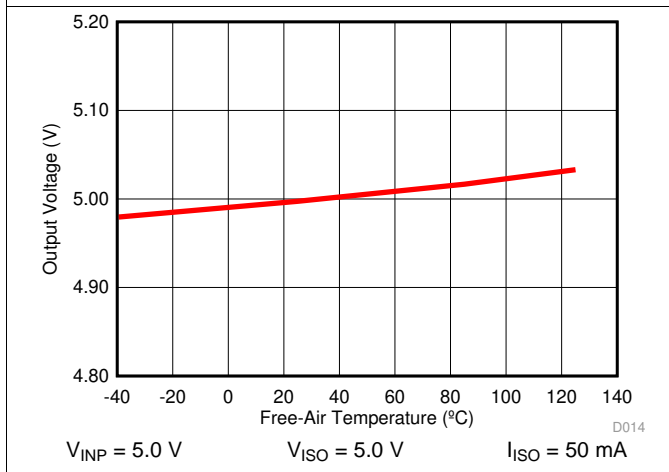

Figure 20. Isolated Supply Voltage (V_{ISO}) vs Free-Air Temperature

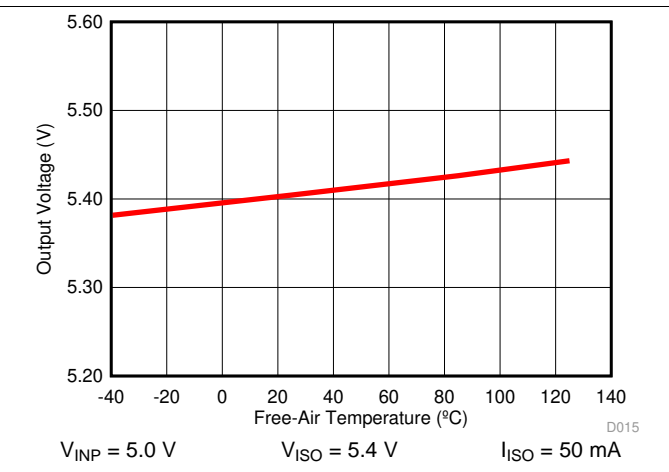
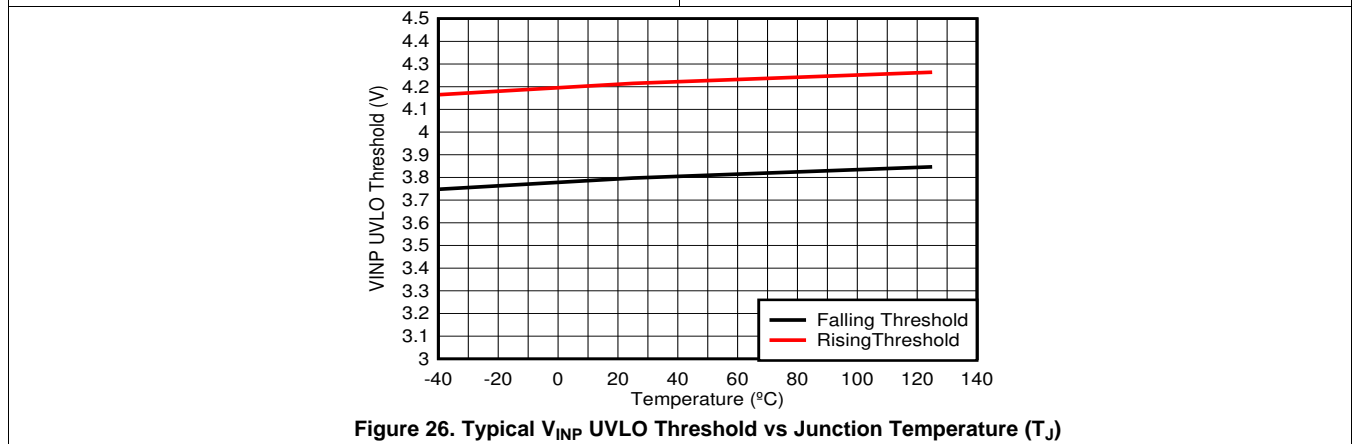
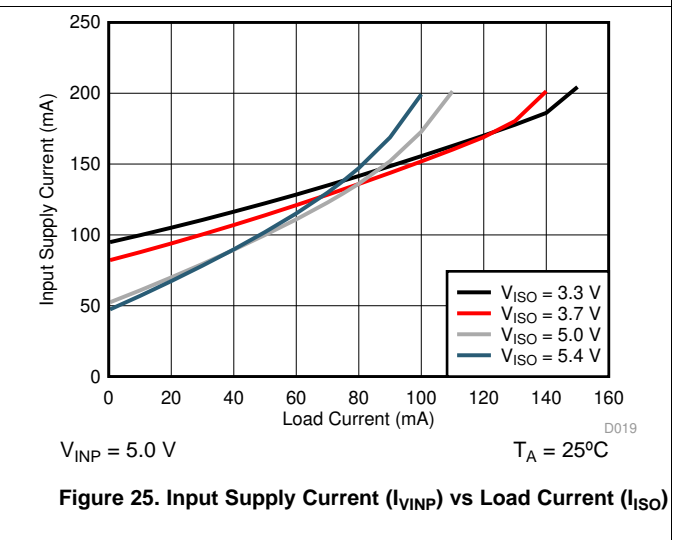
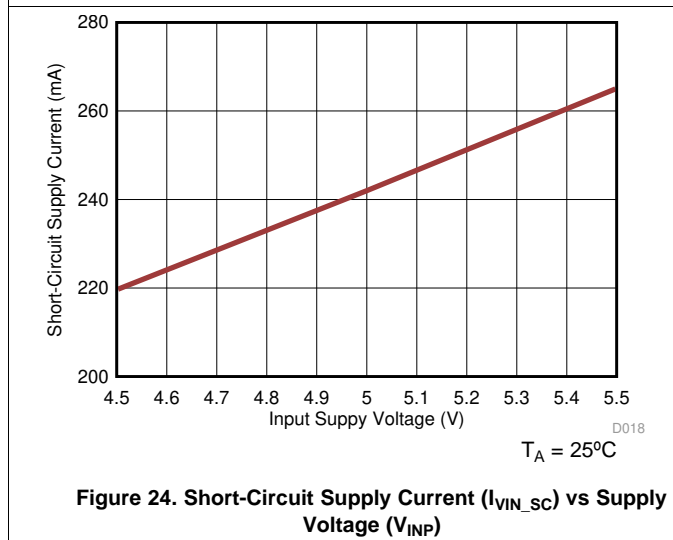
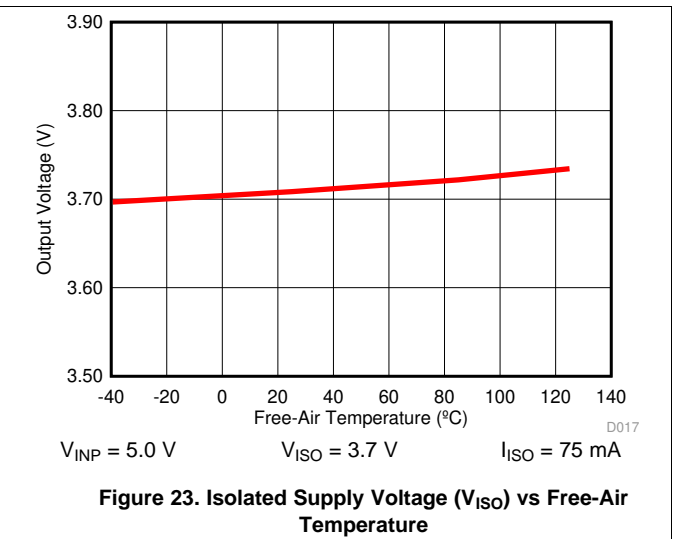
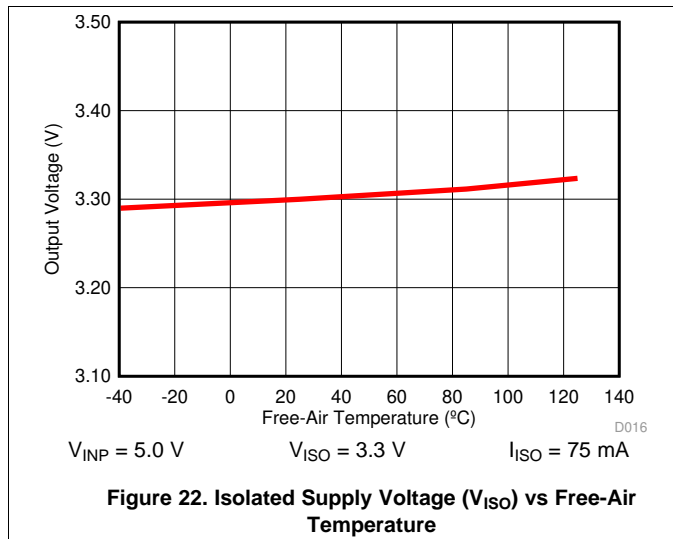

Figure 21. Isolated Supply Voltage (V_{ISO}) vs Free-Air Temperature

Typical Characteristics (continued)



7 Detailed Description

7.1 Overview

The UCC12050 device integrates a high-efficiency, low-emissions isolated DC-DC converter. This approach provides typically 500 mW of clean, steady power across a 5000 V_{RMS} reinforced isolation barrier.

The integrated DC-DC converter uses switched mode operation and proprietary circuit techniques to reduce power losses and boost efficiency. Specialized control mechanisms, clocking schemes, and the use of an on-chip transformer provide high efficiency and low radiated emissions.

The VINP supply is provided to the primary power controller that switches the power stage connected to the integrated transformer. Power is transferred to the secondary side, rectified, and regulated to a level set by the SEL pin condition.

A fast feedback control loop monitors VISO and the output load, and ensures low overshoots and undershoots during load transients. Undervoltage lockout (UVLO) with hysteresis is integrated on the VINP supply, which ensures robust system performance under noisy conditions.

UCC12050 is suitable for applications that have limited board space and require more integration. These devices are also suitable for very-high voltage applications, where power transformers meeting the required isolation specifications are bulky and expensive.

7.2 Functional Block Diagram

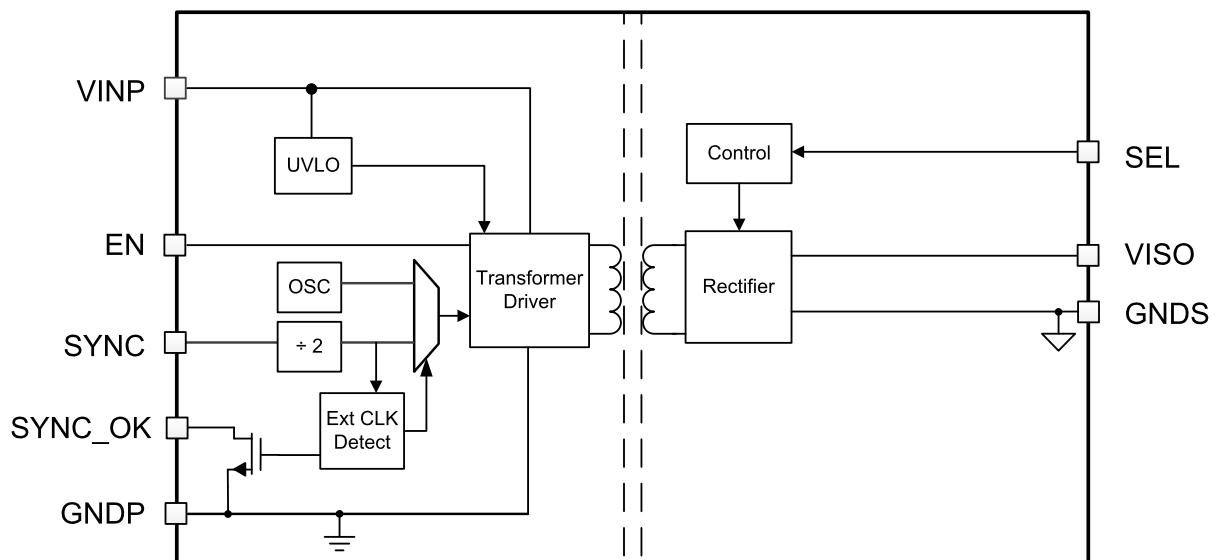

7.3 Feature Description

7.3.1 Enable and Disable

Forcing EN low disables the device, which greatly reduces the VINP power consumption. Pull the EN pin high to enable normal device functionality. The EN pin has a weak internal pull-down resistor, so the device floats to the disable state if the pin is left open.

Feature Description (continued)

7.3.2 UVLO, Power-Up, and Power-Down Behavior

The UCC12050 has an undervoltage lockout (UVLO) on the VINP power supply. Upon power-up, while the VINP voltage is below the threshold voltage V_{UVPR} , the primary side transformer driver is disabled, and VISO output is off. The output powers up once the threshold is met. Likewise, if VINP falls below V_{UVPF} , the converter is disabled and there is no output at VISO. Both UVLO threshold voltages have hysteresis to avoid chattering.

7.3.3 VISO Load Recommended Operating Area

Figure 27 depicts the device V_{ISO} regulation behavior across the output load range, including when the output is overloaded. For proper device operation, ensure that the device VISO output load does not exceed the maximum output current (I_{OUT_MAX}). The value for I_{OUT_MAX} over different temperature and V_{INP} conditions are shown from Figure 8 to Figure 11. The following protection mechanisms will be engaged if the UCC12050 is loaded beyond the recommended operating area:

1. The device limits the maximum output power. If a load exceeding I_{OUT_MAX} is applied, V_{ISO} drops accordingly to meet the maximum power limit.
2. If V_{ISO} drops below nominal 3.8 V while operating in the constant power limit region, the over-power fold-back feature will switch the power converter from active rectification to passive rectification, and the built-in recovery hysteresis will ensure the UCC12050 recovers at a lower output power. The device returns to active rectification when load drops and V_{ISO} increases above nominal 4.3V.
3. The device triggers a soft-start reset if V_{ISO} drops below the nominal 1.8-V threshold. This reset is designed to protect the device during V_{ISO} short-circuit conditions.
4. Thermal shutdown protection disables the converter if the device is operated in any of the above regions long enough to raise the silicon junction temperature above the thermal shutdown threshold. See the [Thermal Shutdown](#) section for more details on this device feature.

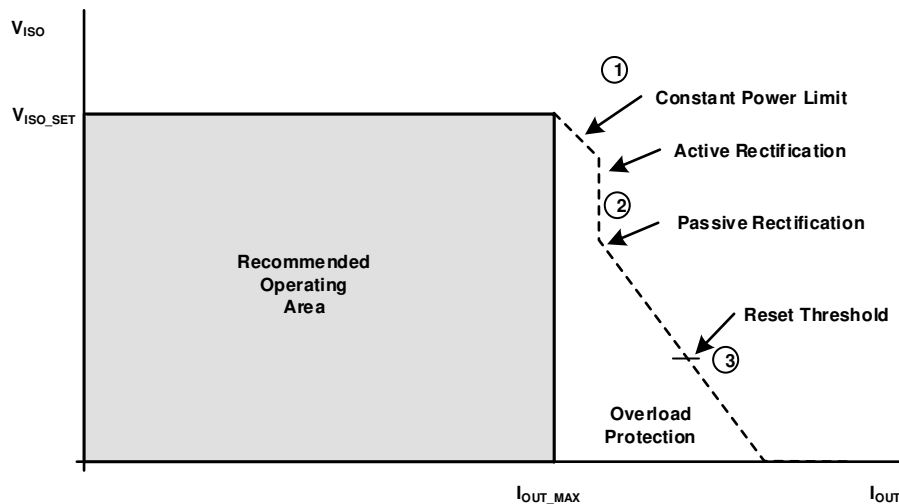

Figure 27. V_{ISO} Load Recommended Operating Area Description

7.3.4 Thermal Shutdown

Thermal protection is also integrated to help prevent the device from getting damaged during overload and short-circuit conditions on the isolated output. Under these conditions, the device temperature starts to increase. When the silicon junction temperature T_j sensed at the primary side die goes above the threshold TSD_{THR} (typical 165°C), thermal shutdown activates and the primary controller turns off which removes the energy supplied to the V_{ISO} load, which causes the device to cool off. When the junction temperature drops approximately 27°C (TSD_{HYST}) from the shutdown point, the device starts to function normally. If an overload or output short-circuit condition prevails, this protection cycle is repeated. Make sure the design prevents the device junction temperatures from reaching such high values.

Feature Description (continued)

7.3.5 External Clocking and Synchronization

The UCC12050 has an internal oscillator trimmed to drive the transformer at 8.0 MHz. An external clock may be applied at the SYNC pin to override the internal oscillator. This external clock will be divided by 2, so the target range for the external clock signal at SYNC is 16 MHz \pm 10%. The SYNC_OK pin is asserted LOW if there is no external SYNC clock or one that is outside of the operating range of the device is detected. In this state, the external clock is ignored and the DC-DC converter is clocked by the internal oscillator. The pin is in high-impedance if a good clock is applied on SYNC.

When more than one DC/DC converter is needed onboard, beat frequencies and other electrical interference can be generated. This interference occurs because of the small variations in switching frequencies between the DC/DC converters. The device overcomes this interference by allowing devices to synchronize to one another. Synchronize multiple devices by connecting the SYNC pins of each device, taking care to minimize the capacitance of all SYNC signal PCB traces. Stray capacitance (greater than 3 pF) may affect the switching frequency.

7.3.6 V_{ISO} Output Voltage Selection

The SEL pin is monitored during power-up — within the first 1 ms after applying VINP above the UVLO rising threshold or enabling via the EN pin — to detect the desired regulation voltage for the VISO output. Note that after this initial monitoring, the SEL pin no longer affects the VISO output level. In order to change the output mode selection, either the EN pin must be toggled or the VINP power supply must be cycled off and back on. Section 6.4 provides more details on the SEL pin functionality.

7.3.7 Electromagnetic Compatibility (EMC) Considerations

UCC12050 devices use emissions reduction schemes for the internal oscillator and advanced internal layout scheme to minimize radiated emissions at the system level.

Many applications in harsh industrial environment are sensitive to disturbances such as electrostatic discharge (ESD), electrical fast transient (EFT), surge and electromagnetic emissions. These electromagnetic disturbances are regulated by international standards such as IEC 61000-4-x and CISPR 32. Although system-level performance and reliability depends, to a large extent, on the application board design and layout, the device incorporates many chip-level design improvements for overall system robustness.

7.4 Device Functional Modes

Table 2 lists the supply functional modes for this device.

Table 2. Device Functional Modes

INPUTS		Isolated Supply Output Voltage (V _{ISO}) Setpoint
EN	SEL	
HIGH	Shorted to VISO	5.0 V
HIGH	100 kΩ to VISO	5.4 V
HIGH	Shorted to GNDS	3.3 V
HIGH	100 kΩ to GNDS	3.7 V
HIGH	OPEN ⁽¹⁾	UNSUPPORTED
LOW	X	0 V

(1) The SEL pin has an internal weak pull-down resistance to ground, but leaving this pin open is not recommended.

8 Application and Implementation

NOTE

Information in the following applications sections is not part of the TI component specification, and TI does not warrant its accuracy or completeness. TI's customers are responsible for determining suitability of components for their purposes. Customers should validate and test their design implementation to confirm system functionality.

8.1 Application Information

The UCC12050 device is suitable for applications that have limited board space and desire more integration. This device is also suitable for very high voltage applications, where power transformers meeting the required isolation specifications are bulky and expensive.

8.2 Typical Application

Figure 28 shows the typical application schematic for the UCC12050 device supplying an isolated load.

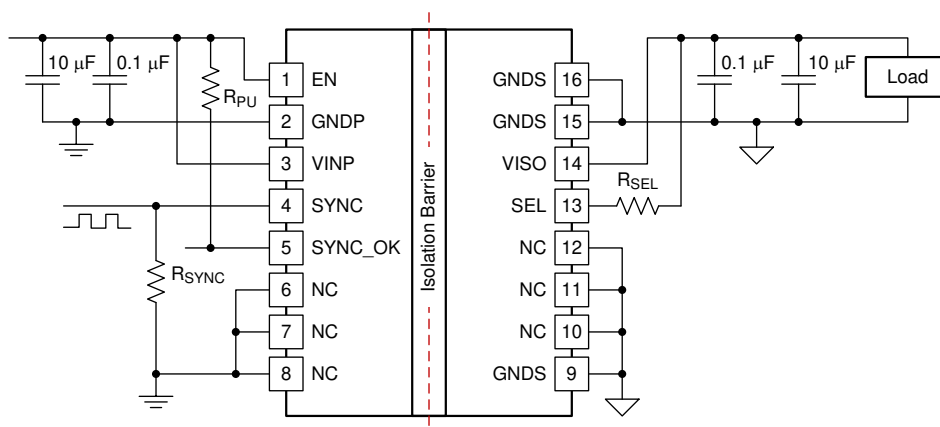

Figure 28. Typical Application

Typical Application (continued)

8.2.1 Design Requirements

To design using UCC12050, a few simple design considerations must be evaluated. [Table 3](#) shows some recommended values for a typical application. See [Power Supply Recommendations](#) and [Layout](#) sections to review other key design considerations for the UCC12050.

Table 3. Design Parameters

PARAMETER	RECOMMENDED VALUE
Input supply voltage, V_{INP}	4.5 V to 5.5 V
Decoupling capacitance between V_{INP} and GNDP	10 μ F, 16 V, \pm 10%, X7R
Decoupling capacitance between V_{ISO} and GNDS ⁽¹⁾	10 μ F, 16 V, \pm 10%, X7R
Optional additional capacitance on VISO or VINP to reduce high-frequency ripple	0.1 μ F, 50 V, \pm 10%, X7R
Pull-up resistor from SYNC_OK to V_{INP} , R_{PU}	100 k Ω
Pull-up resistor from SEL to V_{ISO} for 5.0V output voltage mode, R_{SEL}	0 Ω
Pull-up resistor from SEL to V_{ISO} for 5.4V output voltage mode, R_{SEL}	100 k Ω
Optional SYNC signal impedance-matching resistor, R_{SYNC}	Match source — typical values are 50 Ω , 75 Ω , 100 Ω , or 1 k Ω
External clock signal applied on SYNC	16 MHz

(1) See [VISO Output Capacitor Selection](#) section.

8.2.2 Detailed Design Procedure

Place ceramic decoupling capacitors as close as possible to the device pins. For the input supply, place the capacitor(s) between pin 3 (V_{INP}) and pin 2 (GNDP). For the isolated output supply, place the capacitor(s) between pin 14 (V_{ISO}) and pin 15 (GNDS). This location is of particular importance to the input decoupling capacitor, because this capacitor supplies the transient current associated with the fast switching waveforms of the power drive circuits. The recommended capacitor value is 10 μ F. Ensure the capacitor dielectric material is compatible with the target application temperature.

8.2.2.1 VISO Output Capacitor Selection

The UCC12050 is optimized to run with an effective output capacitance of 5 μ F to 20 μ F. A ceramic capacitor is recommended. Ceramic capacitors have DC-Bias and temperature derating effects, which both have influence the final effective capacitance. Choose the right capacitor carefully in combination with considering its package size, dielectric and voltage rating. It is good design practice to include one 0.1- μ F capacitor close to the device for high-frequency noise reduction.

8.2.3 Application Curves

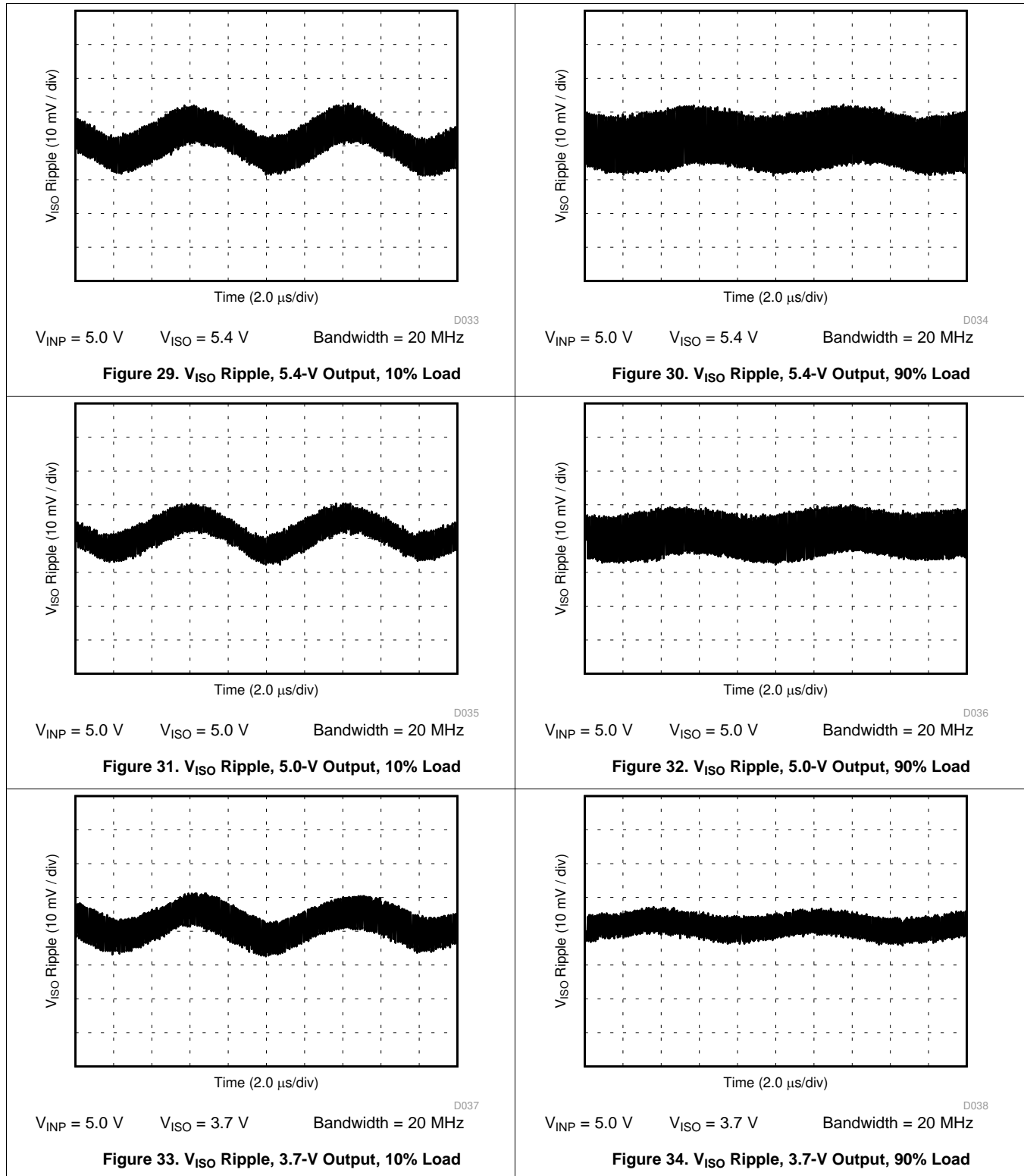

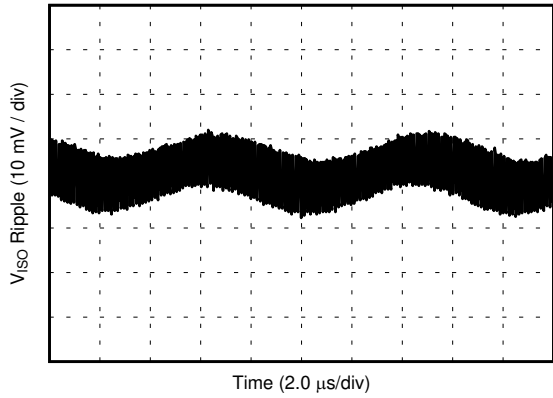

$V_{INP} = 5.0\text{ V}$ $V_{ISO} = 3.3\text{ V}$ Bandwidth = 20 MHz

Figure 35. V_{ISO} Ripple, 3.3-V Output, 10% Load

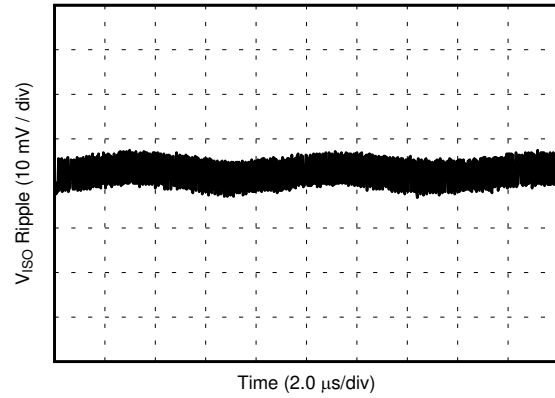

$V_{INP} = 5.0\text{ V}$ $V_{ISO} = 3.3\text{ V}$ Bandwidth = 20 MHz

Figure 36. V_{ISO} Ripple, 3.3-V Output, 90% Load

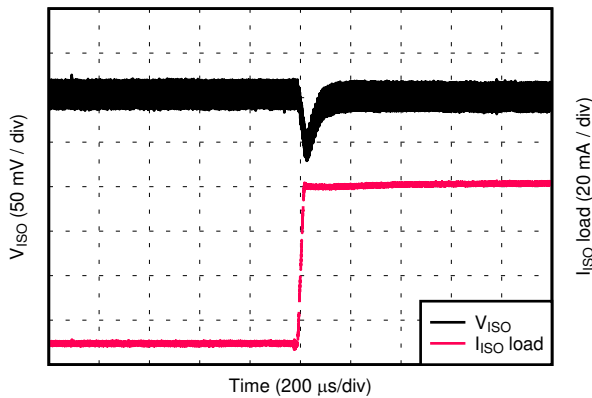

Figure 37. V_{ISO} Load Transient Response, 10% to 90% Load Step, 5.0-V Input, 5.4-V Output

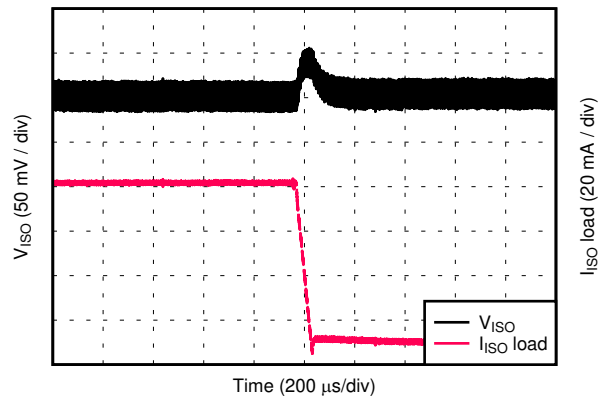

Figure 38. V_{ISO} Load Transient Response, 90% to 10% Load Step, 5.0-V Input, 5.4-V Output

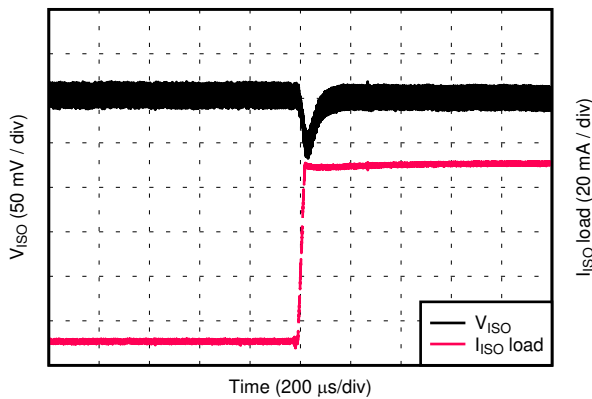

Figure 39. V_{ISO} Load Transient Response, 10% to 90% Load Step, 5.0-V Input, 5.0-V Output

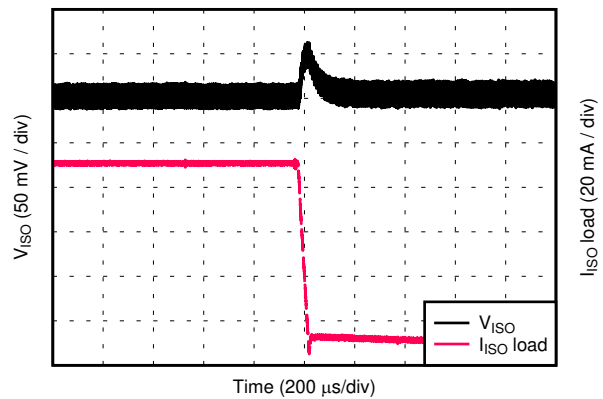

Figure 40. V_{ISO} Load Transient Response, 90% to 10% Load Step, 5.0-V Input, 5.0-V Output

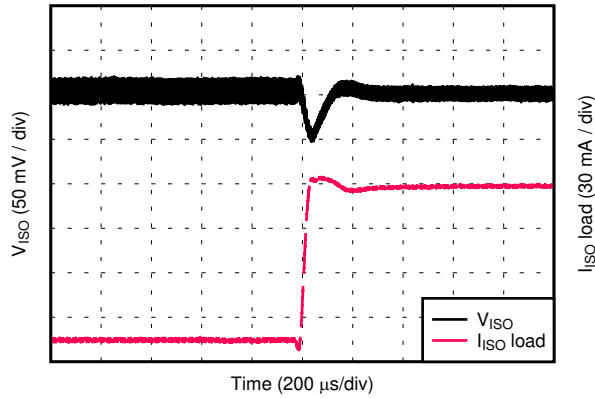

Figure 41. V_{ISO} Load Transient Response, 10% to 90% Load Step, 5.0-V Input, 3.7-V Output

D045

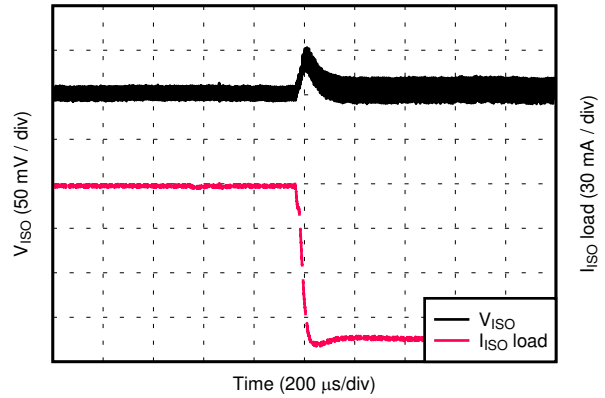

Figure 42. V_{ISO} Load Transient Response, 90% to 10% Load Step, 5.0-V Input, 3.7-V Output

D046

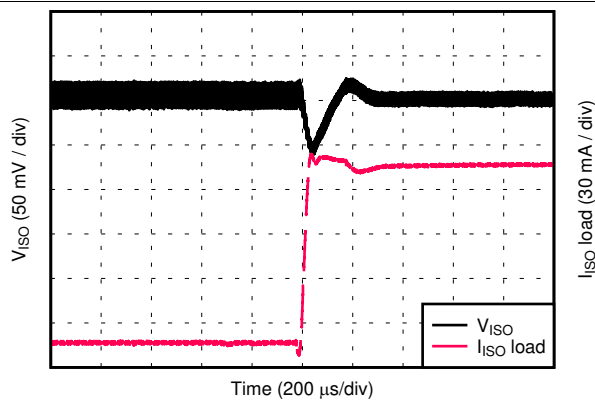

Figure 43. V_{ISO} Load Transient Response, 10% to 90% Load Step, 5.0-V Input, 3.3-V Output

D047

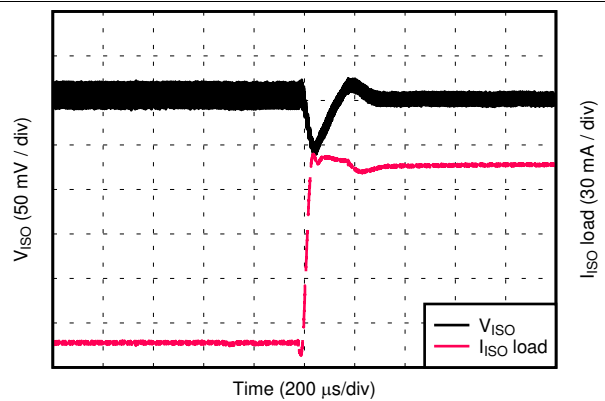

Figure 44. V_{ISO} Load Transient Response, 90% to 10% Load Step, 5.0-V Input, 3.3-V Output

D047

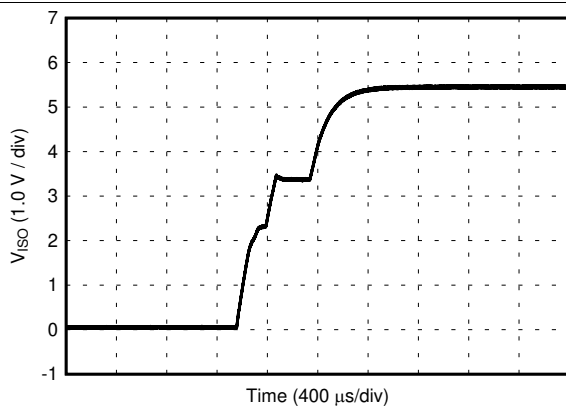

Figure 45. V_{ISO} Soft Start at 10% Rated Load, 5.0-V Input, 5.4-V Output

D049

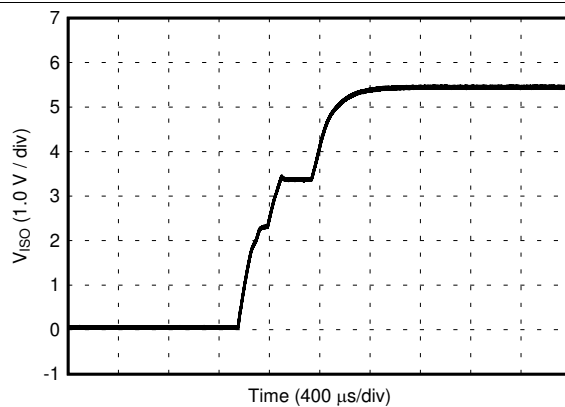
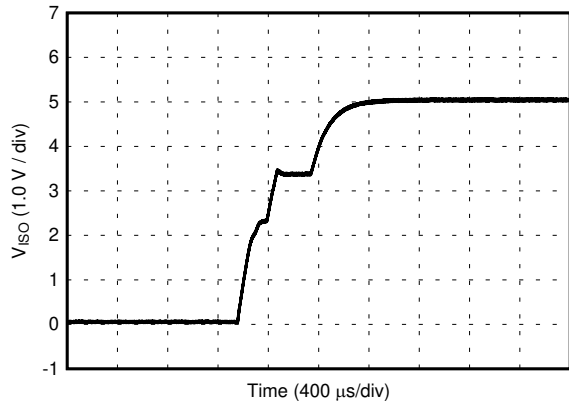
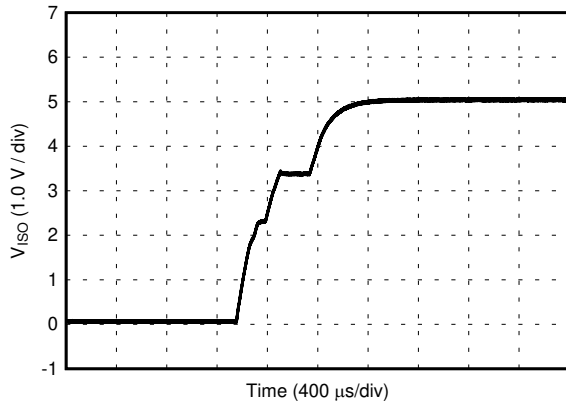

Figure 46. V_{ISO} Soft Start at 90% Rated Load, 5.0-V Input, 5.4-V Output

D050



D051
Figure 47. V_{ISO} Soft Start at 10% Rated Load, 5.0-V Input, 5.0-V Output



D052
Figure 48. V_{ISO} Soft Start at 90% Rated Load, 5.0-V Input, 5.0-V Output

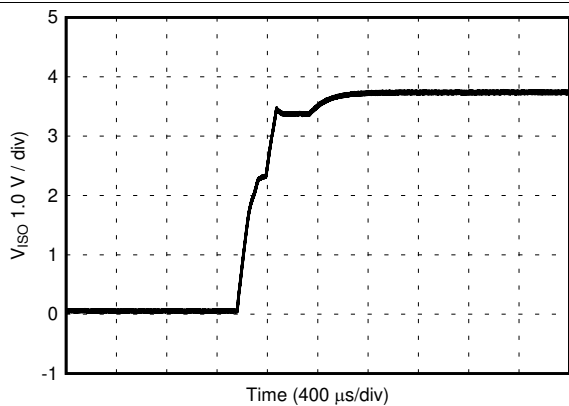

D053
Figure 49. V_{ISO} Soft Start at 10% Rated Load, 5.0-V Input, 3.7-V Output

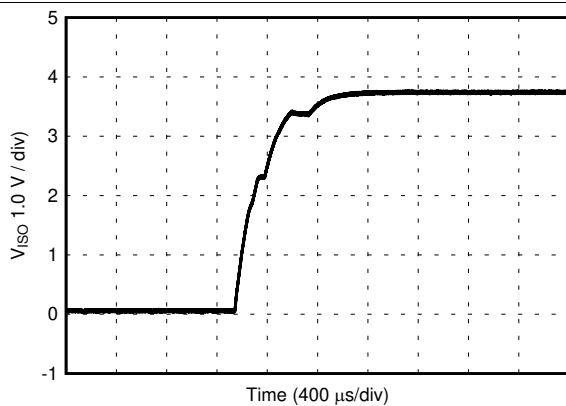

D054
Figure 50. V_{ISO} Soft Start at 90% Rated Load, 5.0-V Input, 3.7-V Output

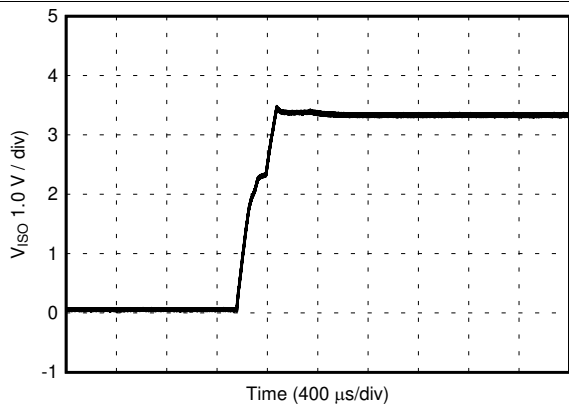

D055
Figure 51. V_{ISO} Soft Start at 10% Rated Load, 5.0-V Input, 3.3-V Output

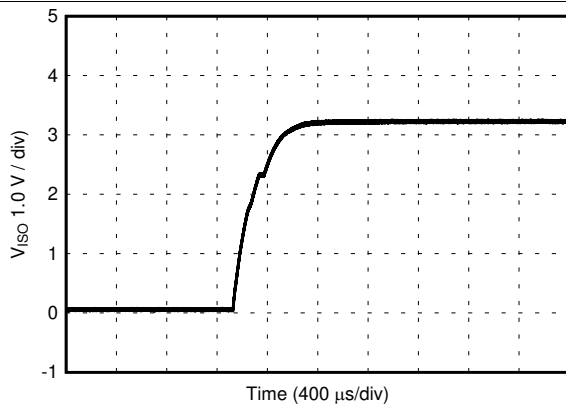

D056
Figure 52. V_{ISO} Soft Start at 90% Rated Load, 5.0-V Input, 3.3-V Output

9 Power Supply Recommendations

The recommended input supply voltage (VINP) for the UCC12050 is between 4.5 V and 5.5 V. To help ensure reliable operation, adequate decoupling capacitors must be located as close to supply pins as possible. Place local bypass capacitors between the VINP and GNDP pins at the input, and between VISO and GNDS at the isolated output supply. Low ESR, ceramic surface mount capacitors are recommended. It is further suggested that one place two such capacitors: one with a value of 10 μ F for supply bypassing, and an additional 100-nF capacitor in parallel for high frequency filtering. The input supply must have an appropriate current rating to support output load required by the end application.

10 Layout

10.1 Layout Guidelines

The UCC12050 integrated isolated power solution simplifies system design and reduces board area usage. Proper PCB layout is important in order to achieve optimum performance. Here is a list of recommendations:

1. Place decoupling capacitors as close as possible to the device pins. For the input supply, place the capacitor(s) between pin 3 (VINP) and pin 2 (GNDP). For the isolated output supply, place the capacitor(s) between pin 14 (VISO) and pin 15 (GNDS). This location is of particular importance to the input decoupling capacitor, because this capacitor supplies the transient current associated with the fast switching waveforms of the power drive circuits.
2. Because the device does not have a thermal pad for heat-sinking, the device dissipates heat through the respective GND pins. Ensure that enough copper (preferably a connection to the ground plane) is present on all GNDP and GNDS pins for best heat-sinking.
3. If space and layer count allow, it is also recommended to connect the VINP, GNDP, VISO and GNDS pins to internal ground or power planes through multiple vias of adequate size. Alternatively, make traces for these nets as wide as possible to minimize losses.
4. TI also recommends grounding the no-connect pins (NC) to their respective ground planes. For pins 6, 7, and 8, connect to GNDP. For pins 10, 11, and 12, connect to GNDS. This will allow more continuous ground planes and larger thermal mass for heat-sinking.
5. A minimum of four layers is recommended to accomplish a low-EMI PCB design. Inner layers can be spaced closer than outer layers and used to create a high-frequency bypass capacitor between GNDP and GNDS to reduce radiated emissions. Ensure proper spacing, both inter-layer and layer-to-layer, is implemented to avoid reducing isolation capabilities. These spacings will vary based on the printed circuit board construction parameters, such as dielectric material and thickness.
6. Pay close attention to the spacing between primary ground plane (GNDP) and secondary ground plane (GNDS) on the PCB outer layers. The effective creepage and or clearance of the system will be reduced if the two ground planes have a lower spacing than that of the device package.
7. To ensure isolation performance between the primary and secondary side, avoid placing any PCB traces or copper below the UCC12050 device on the outer copper layers.

10.2 Layout Example

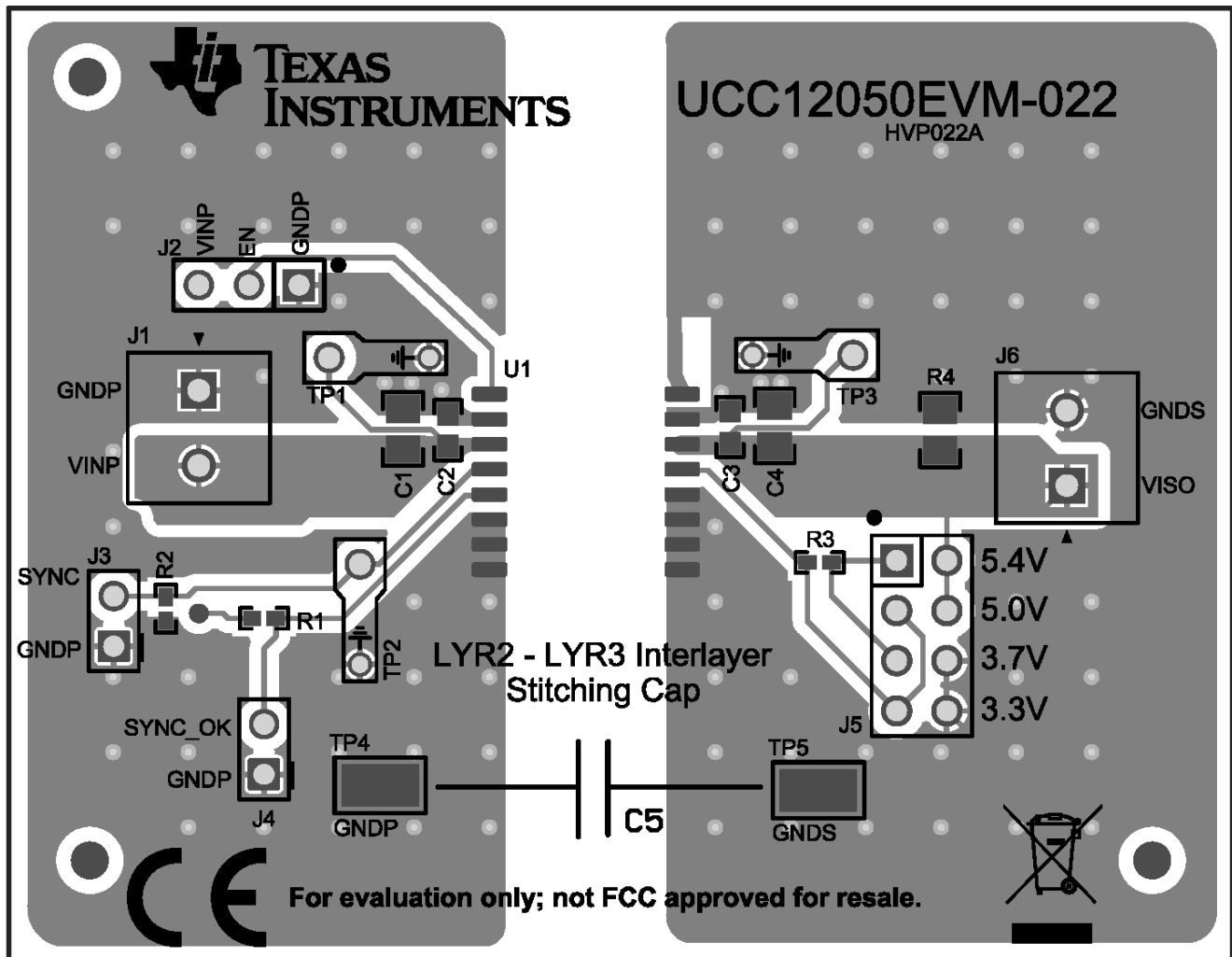

Figure 53. Layout Example

11 Device and Documentation Support

11.1 Device Support

11.1.1 Development Support

For development support, refer to:

- [High-efficiency, low-emission, isolated DC/DC converter-based analog input module reference design](#)
- [Isolated delta-sigma modulator based AC/DC voltage and current measurement module reference design](#)
- [Isolated power architecture reference design for communication and analog input/output modules](#)

11.2 Documentation Support

11.2.1 Related Documentation

For related documentation see the following:

- [UCC12050 Evaluation Module User Guide](#)
- [Isolation Glossary](#)
- [A Reinforced-isolated Analog Input Chain for Space-constrained Applications](#)

11.3 Receiving Notification of Documentation Updates

To receive notification of documentation updates, navigate to the device product folder on **Ti.com**. In the upper right corner, click on *Alert me* to register and receive a weekly digest of any product information that has changed. For change details, review the revision history included in any revised document.

11.4 Community Resources

[TI E2E™ support forums](#) are an engineer's go-to source for fast, verified answers and design help — straight from the experts. Search existing answers or ask your own question to get the quick design help you need.

Linked content is provided "AS IS" by the respective contributors. They do not constitute TI specifications and do not necessarily reflect TI's views; see TI's [Terms of Use](#).

11.5 Trademarks

E2E is a trademark of Texas Instruments.

11.6 Electrostatic Discharge Caution



This integrated circuit can be damaged by ESD. Texas Instruments recommends that all integrated circuits be handled with appropriate precautions. Failure to observe proper handling and installation procedures can cause damage.

ESD damage can range from subtle performance degradation to complete device failure. Precision integrated circuits may be more susceptible to damage because very small parametric changes could cause the device not to meet its published specifications.

11.7 Glossary

[SLYZ022](#) — *TI Glossary*.

This glossary lists and explains terms, acronyms, and definitions.

12 Mechanical and Packaging Information

The following pages include mechanical, packaging, and orderable information. This information is the most current data available for the designated devices. This data is subject to change without notice and revision of this document. For browser-based versions of this data sheet, refer to the left-hand navigation.

PACKAGING INFORMATION

Orderable Device	Status (1)	Package Type	Package Drawing	Pins	Package Qty	Eco Plan (2)	Lead finish/ Ball material (6)	MSL Peak Temp (3)	Op Temp (°C)	Device Marking (4/5)	Samples
UCC12050DVE	ACTIVE	SO-MOD	DVE	16	40	RoHS & Green	NIPDAU	Level-3-260C-168 HR	-40 to 125	UCC12050	Samples
UCC12050DVER	ACTIVE	SO-MOD	DVE	16	2000	RoHS & Green	NIPDAU	Level-3-260C-168 HR	-40 to 125	UCC12050	Samples

(1) The marketing status values are defined as follows:

ACTIVE: Product device recommended for new designs.

LIFEBUY: TI has announced that the device will be discontinued, and a lifetime-buy period is in effect.

NRND: Not recommended for new designs. Device is in production to support existing customers, but TI does not recommend using this part in a new design.

PREVIEW: Device has been announced but is not in production. Samples may or may not be available.

OBSOLETE: TI has discontinued the production of the device.

(2) **RoHS:** TI defines "RoHS" to mean semiconductor products that are compliant with the current EU RoHS requirements for all 10 RoHS substances, including the requirement that RoHS substance do not exceed 0.1% by weight in homogeneous materials. Where designed to be soldered at high temperatures, "RoHS" products are suitable for use in specified lead-free processes. TI may reference these types of products as "Pb-Free".

RoHS Exempt: TI defines "RoHS Exempt" to mean products that contain lead but are compliant with EU RoHS pursuant to a specific EU RoHS exemption.

Green: TI defines "Green" to mean the content of Chlorine (Cl) and Bromine (Br) based flame retardants meet JS709B low halogen requirements of <=1000ppm threshold. Antimony trioxide based flame retardants must also meet the <=1000ppm threshold requirement.

(3) MSL, Peak Temp. - The Moisture Sensitivity Level rating according to the JEDEC industry standard classifications, and peak solder temperature.

(4) There may be additional marking, which relates to the logo, the lot trace code information, or the environmental category on the device.

(5) Multiple Device Markings will be inside parentheses. Only one Device Marking contained in parentheses and separated by a "~" will appear on a device. If a line is indented then it is a continuation of the previous line and the two combined represent the entire Device Marking for that device.

(6) Lead finish/Ball material - Orderable Devices may have multiple material finish options. Finish options are separated by a vertical ruled line. Lead finish/Ball material values may wrap to two lines if the finish value exceeds the maximum column width.

Important Information and Disclaimer:The information provided on this page represents TI's knowledge and belief as of the date that it is provided. TI bases its knowledge and belief on information provided by third parties, and makes no representation or warranty as to the accuracy of such information. Efforts are underway to better integrate information from third parties. TI has taken and continues to take reasonable steps to provide representative and accurate information but may not have conducted destructive testing or chemical analysis on incoming materials and chemicals. TI and TI suppliers consider certain information to be proprietary, and thus CAS numbers and other limited information may not be available for release.

In no event shall TI's liability arising out of such information exceed the total purchase price of the TI part(s) at issue in this document sold by TI to Customer on an annual basis.

TAPE AND REEL INFORMATION



QUADRANT ASSIGNMENTS FOR PIN 1 ORIENTATION IN TAPE



*All dimensions are nominal

Device	Package Type	Package Drawing	Pins	SPQ	Reel Diameter (mm)	Reel Width W1 (mm)	A0 (mm)	B0 (mm)	K0 (mm)	P1 (mm)	W (mm)	Pin1 Quadrant
UCC12050DVER	SO-MOD	DVE	16	2000	330.0	16.4	10.75	10.7	2.7	12.0	16.0	Q1

TAPE AND REEL BOX DIMENSIONS



*All dimensions are nominal

Device	Package Type	Package Drawing	Pins	SPQ	Length (mm)	Width (mm)	Height (mm)
UCC12050DVER	SO-MOD	DVE	16	2000	350.0	350.0	43.0



PACKAGE OUTLINE

DVE0016A

SO-MOD - 2.65 mm max height

SMALL OUTLINE INTEGRATED CIRCUIT

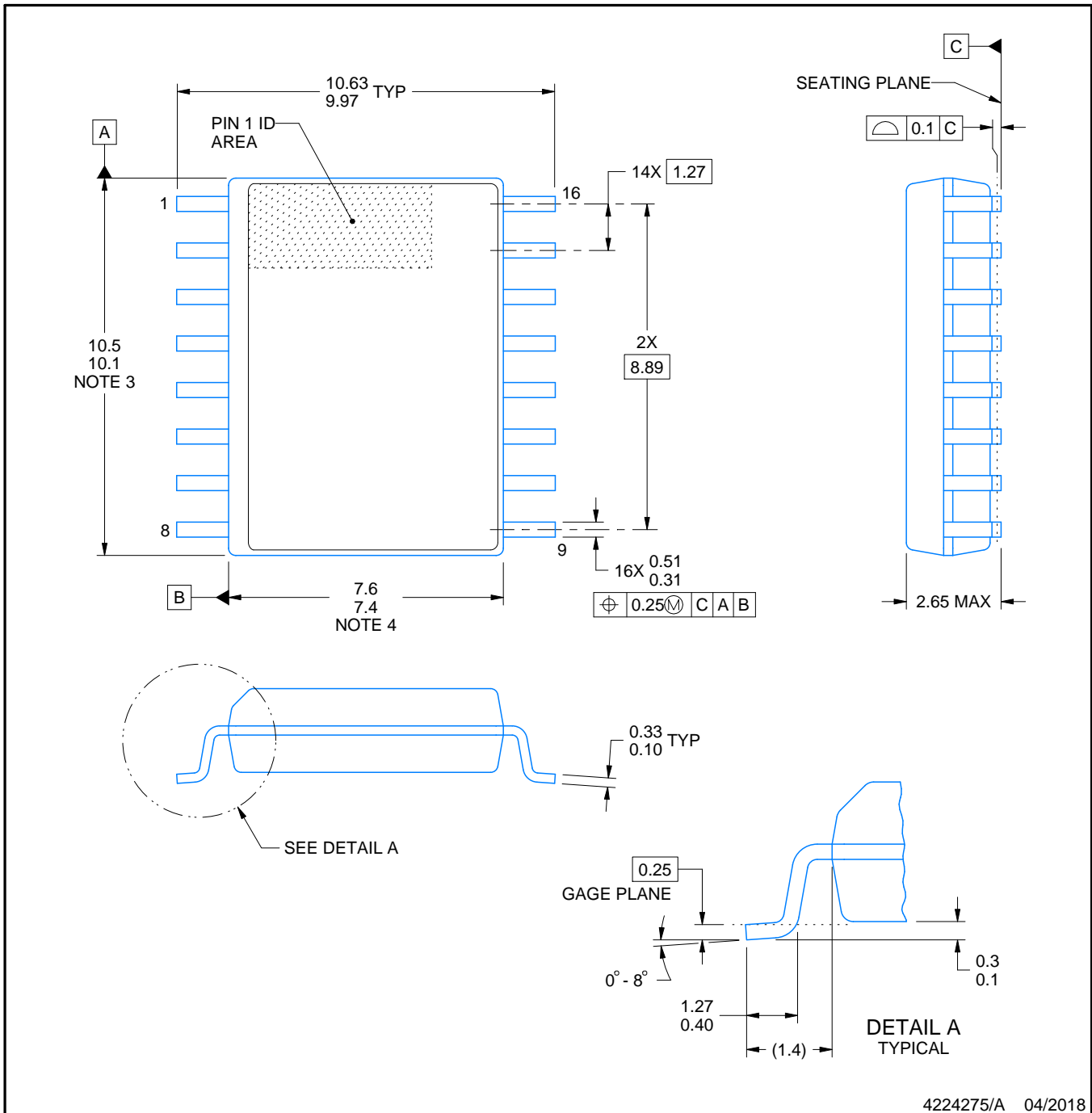

NOTES:

1. All linear dimensions are in millimeters. Any dimensions in parenthesis are for reference only. Dimensioning and tolerancing per ASME Y14.5M.
2. This drawing is subject to change without notice.
3. This dimension does not include mold flash, protrusions, or gate burrs. Mold flash, protrusions, or gate burrs shall not exceed 0.15 mm, per side.
4. This dimension does not include interlead flash. Interlead flash shall not exceed 0.25 mm, per side.
5. Reference JEDEC registration MS-013.

EXAMPLE BOARD LAYOUT

DVE0016A

SO-MOD - 2.65 mm max height

SMALL OUTLINE INTEGRATED CIRCUIT

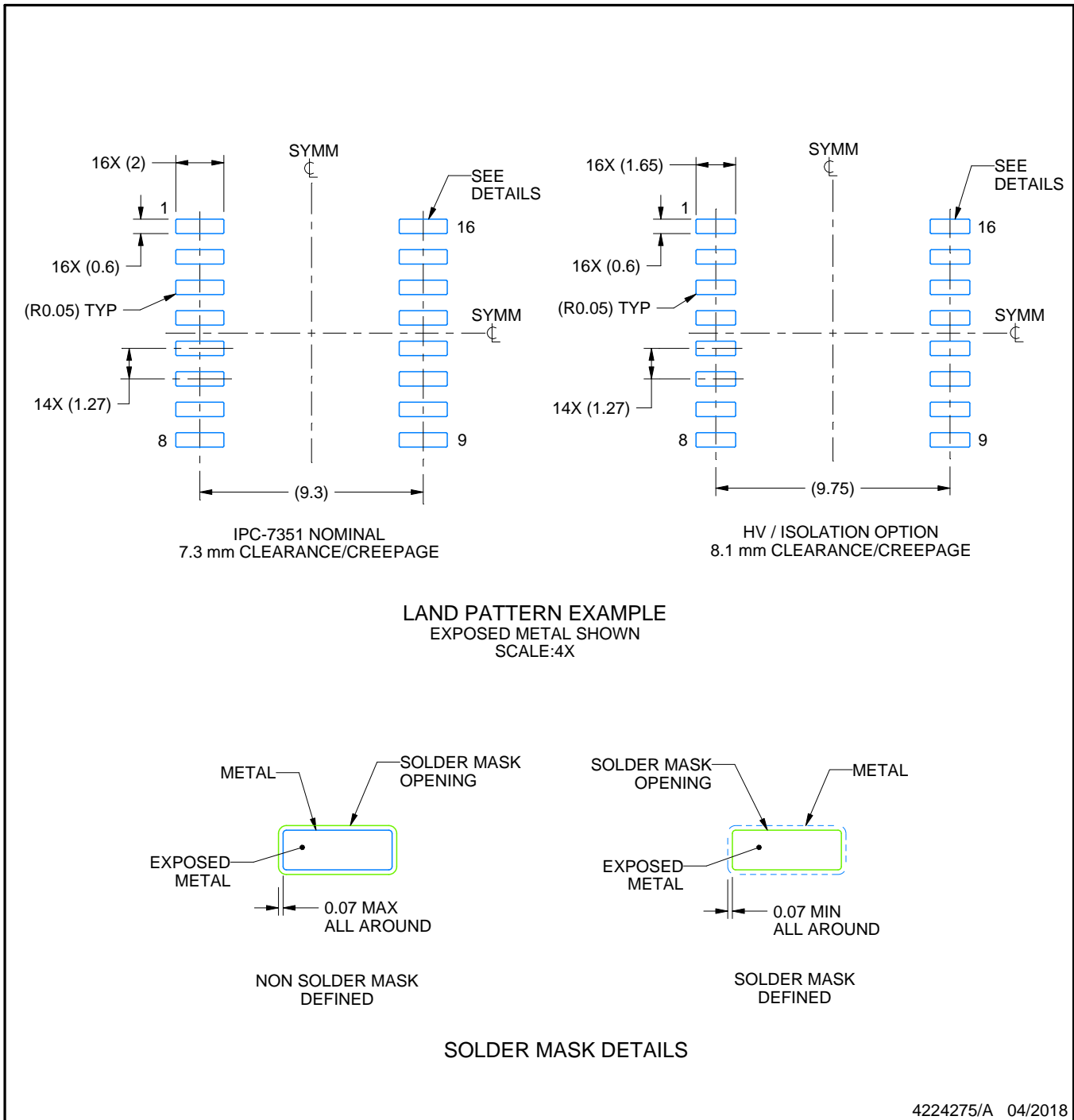

NOTES: (continued)

6. Publication IPC-7351 may have alternate designs.
7. Solder mask tolerances between and around signal pads can vary based on board fabrication site.

EXAMPLE STENCIL DESIGN

DVE0016A

SO-MOD - 2.65 mm max height

SMALL OUTLINE INTEGRATED CIRCUIT

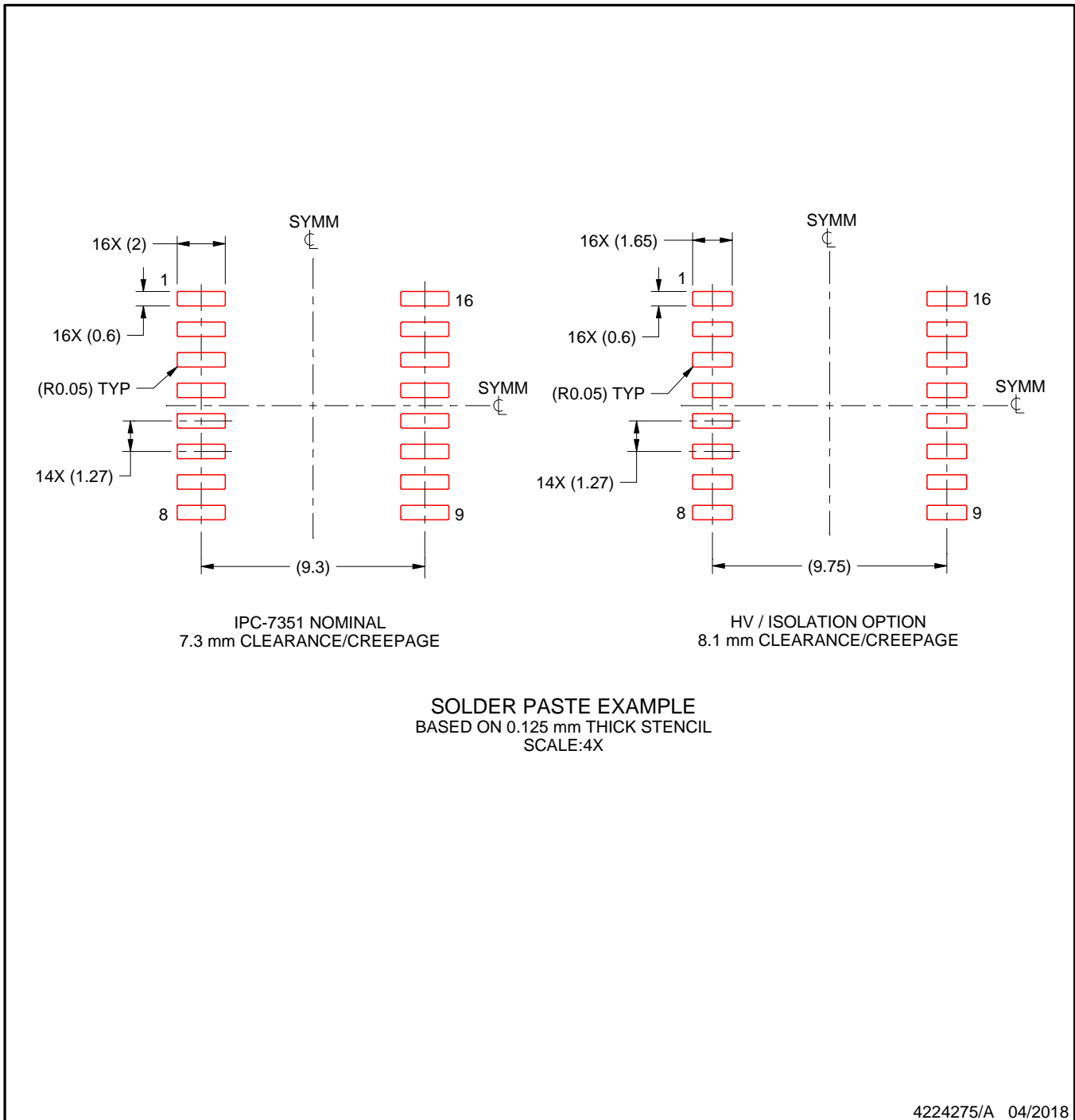

NOTES: (continued)

8. Laser cutting apertures with trapezoidal walls and rounded corners may offer better paste release. IPC-7525 may have alternate design recommendations.
9. Board assembly site may have different recommendations for stencil design.

IMPORTANT NOTICE AND DISCLAIMER

TI PROVIDES TECHNICAL AND RELIABILITY DATA (INCLUDING DATASHEETS), DESIGN RESOURCES (INCLUDING REFERENCE DESIGNS), APPLICATION OR OTHER DESIGN ADVICE, WEB TOOLS, SAFETY INFORMATION, AND OTHER RESOURCES "AS IS" AND WITH ALL FAULTS, AND DISCLAIMS ALL WARRANTIES, EXPRESS AND IMPLIED, INCLUDING WITHOUT LIMITATION ANY IMPLIED WARRANTIES OF MERCHANTABILITY, FITNESS FOR A PARTICULAR PURPOSE OR NON-INFRINGEMENT OF THIRD PARTY INTELLECTUAL PROPERTY RIGHTS.

These resources are intended for skilled developers designing with TI products. You are solely responsible for (1) selecting the appropriate TI products for your application, (2) designing, validating and testing your application, and (3) ensuring your application meets applicable standards, and any other safety, security, or other requirements. These resources are subject to change without notice. TI grants you permission to use these resources only for development of an application that uses the TI products described in the resource. Other reproduction and display of these resources is prohibited. No license is granted to any other TI intellectual property right or to any third party intellectual property right. TI disclaims responsibility for, and you will fully indemnify TI and its representatives against, any claims, damages, costs, losses, and liabilities arising out of your use of these resources.

TI's products are provided subject to TI's Terms of Sale (www.ti.com/legal/termsofsale.html) or other applicable terms available either on ti.com or provided in conjunction with such TI products. TI's provision of these resources does not expand or otherwise alter TI's applicable warranties or warranty disclaimers for TI products.

Mailing Address: Texas Instruments, Post Office Box 655303, Dallas, Texas 75265
Copyright © 2020, Texas Instruments Incorporated